

CENTRAL ORDNANCE DEPOT - KARACHI

MOST IMED

Central Ordnance Depot
Karachi - 15
Tel: Mil - 021-34570010
1002/KRD- 3/24-25/ /LP
16 Dec 2024

To: PPRA Islamabad

Subject: **Amendment in Tender Inquiry no.1002/KRD-3/2024-25/LP dated 11 Dec 2024**

1. Please add **Annexure 'D'** and items after ser 310 at **annexure 'B'** to our tender inquiry no.**1002/KRD-3/2024-25/LP** dated **11 Dec 2024** having **PPRA code no. TS552759E dated 11 Dec 2024** which will be opened on **30 Dec 2024**.
2. Forwarded for information and publication at PPRA's website immediately, please.

Maj
LPO
(Muhammad Waseem Imdad)

Annexur 'B'
KRD ltr no. 1002/KRD-03/24-25/LP

TENDER ORDNANCE STORES - FY 2024-25

Ser	Nomenclature	A/U	Rate
311	Needle Oil Cooker	Nos	
312	Heater Spring (5000W)	Nos	
313	Carton 7 Ply Size 4' x 2' x 2'	Nos	

Annexure 'D'

To COD Karachi letter no.1002/KRD-3/24-25/LP

TENDER FENCING STORES 11/12 CORPS

Ser	Nomenclature	A/U	Remarks
1.	Diamond Mesh 9' x 25'	Roll	Specification attached
2.	Diamond Mesh 10.5' x 25'	Roll	
3.	Pole 11.5' along with Angle Iron 2' (V Shape with 26" each prong Length)	Nos	
4.	Pole 13.5' along with Angle Iron 2' (V Shape with 26" each prong Length)	Nos	
5.	Razor Coil 18" (13 Kg / Coil)	Roll	
6.	Razor Coil 36" (21 Kg / Coil)	Roll	
7.	Barbed Wire (50 Kg / Roll)	Roll	
8.	Short Pickets 2'	Nos	
9.	Binding Wire	Kg	
10.	New Jubilee Clamp Steel	Nos	
11.	Binding Clamps	Nos	
12.	Mesh Hooks	Nos	
13.	Top SWR	Ft	
14.	Anchor Bars	Nos	
15.	DT Clamps 6mm	Nos	
16.	Razor Coil Hooks	Nos	
17.	Gate H/S	Prs	
18.	Gate F/S	Prs	
19.	Sign Board	Nos	
20.	Danger Board	Nos	
21.	Warning Board	Nos	
22.	Mine Marker	Nos	
23.	Jointing Clips	Kg	
24.	Cement	Bag	-
25.	Sand	Cft	-
26.	Crush	Cft	-

Special Instruction: -

- a. **Rate of items will be quoted along with standard packing i.e. wooden box, carton, cardboard box, crate etc.**
- b. **Technical Specifications and Details of each item are attached.**
- c. **Sample of quoted rate must be provided with Tender Inquiry otherwise quotation will be rejected.**
- d. **Rate will be quoted as per approved Army Specs items.**
- e. **Rate quoted by Firm will be valid for delivery throughout Pakistan.**

RESTD**Appendix 'A'****TECH DATA****MESH**

(Tech data is property of Govt of Pakistan and liable to amendments any time. It must be returned to Chief Inspector, Inspectorate of Army Stores and Clothing Karachi on Demand or immediately on completion the purpose for which it was issued)

Ser	Parameters	Specified Limits	Std Method
1.	Use	Fencing equipment for Border security	-
2.	Make, Shape and Design	As per approved sample and drawing	
3.	Colour	Silver	
4.	Gauge	8 SWG	SWG
5.	Dia of Wire	4.1 mm (Min)	ASTM A 817
6.	Mesh Size	2 x 2 inch	ASTM A 392
7.	Material	Mild Steel	BS 1449
8.	Carbon%	≤ 0.12%	BS 1449
9.	Tensile Strength	500 MPa (Min)	ASTM A 370
10.	Breaking Strength	450 MPa (Min)	ASTM A 121
11.	Elongation %	10 ± 2 %	ASTM A 370
12.	Galvanization	Hot Dip Galvanized No Copper deposition up to 4 th dip	BS 443:1982
13.	Zinc Coating (g/ m ²)	275 (Min)	ASTM A 817 Table-1 (Type-II Class-3)
14.	Packing	Standard Packing as per latest instruction(s) by consignee	-
15.	Roll Size		
	a. Home side	25 x 9 ft	Measuring Scale
	b. For Side	25 x 10.5 ft	
	c. Qty req per Km	132 Roll each side	-

DIAMOND MESH (9' & 10.5')

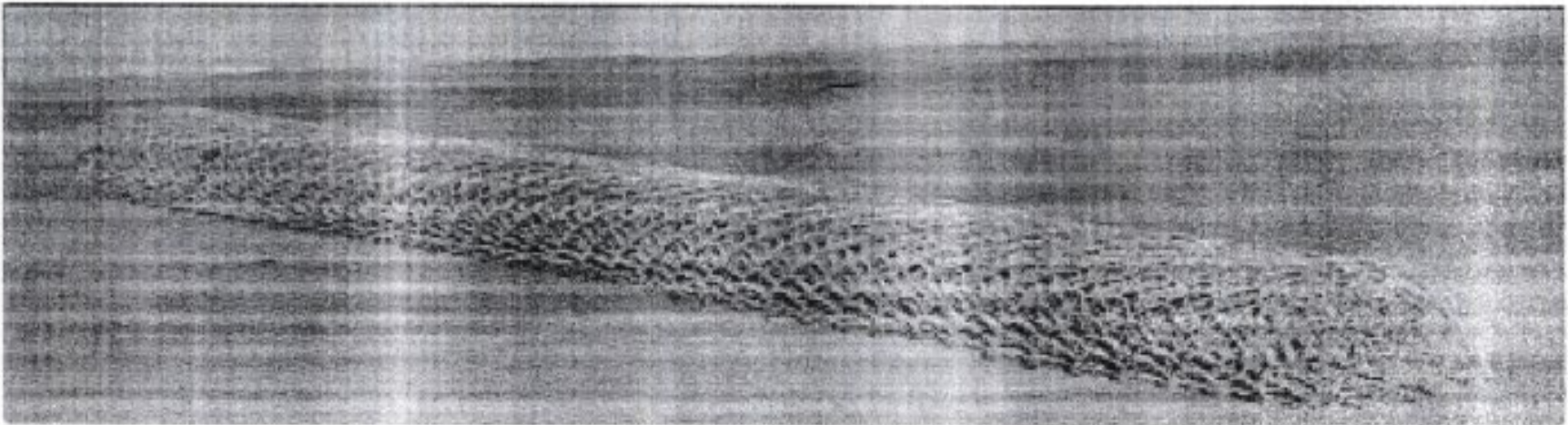
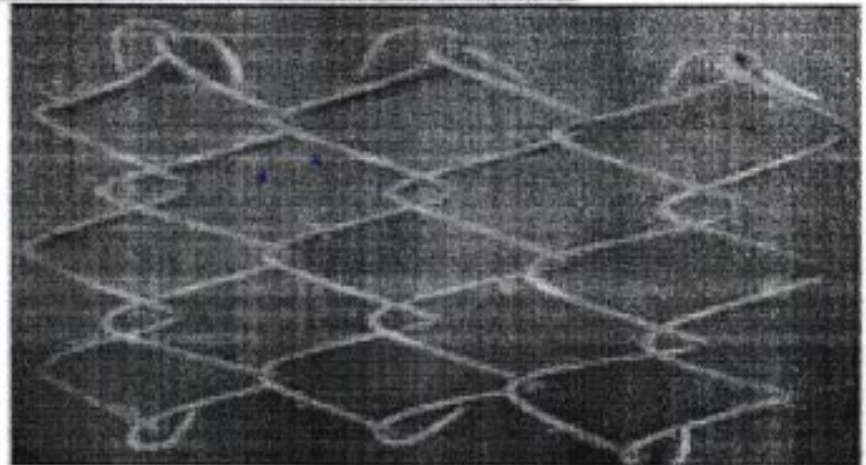
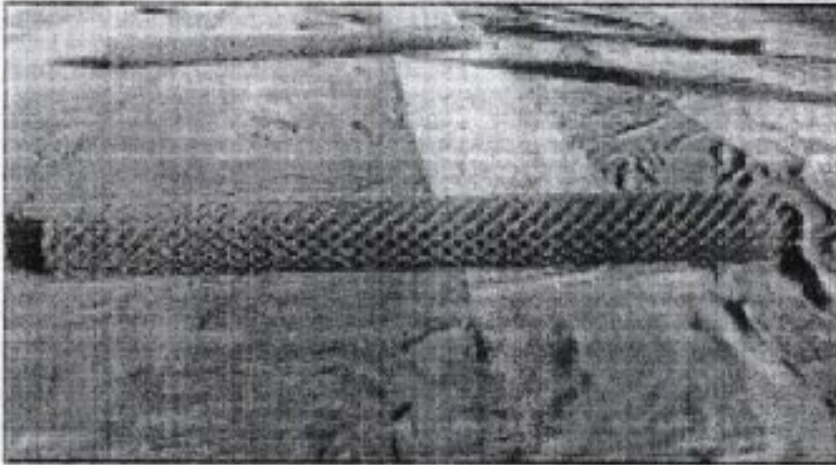

TECH DATA
POLE (3", 2" and 1.5")

(Tech data is property of Govt of Pakistan and liable to amendments any time. It must be returned to Chief Inspector, Inspectorate of Army Stores and Clothing Karachi on Demand or immediately on completion the purpose for which it was issued)

Ser	Parameters	Specified Limits			Std Method
1.	Use	Fencing equipment for Border security			
2.	Make, Shape and Design	As per approved sample and drawing			
3.	Colour	Silver			
4.	Inner Dia	3 inch	2 inch	1.5 inch	
5.	Gauge	8 SWG	15 SWG	16 SWG	SWG
6.	Thickness	4mm (Min)	1.8mm (Min)	1.6mm (Min)	Micrometer
7.	Hardness	78±2 HRB	68±2 HRB	68±2 HRB	ASTM 370/ ASTM E 18
8.	Material	Mild Steel			ASTM E415
9.	Carbon%	≤ 0.12%			
10.	Tensile Strength	410 ± 10 MPa	380 ± 10 MPa	345 ± 10 MPa	ASTM 370
11.	Breaking Strength	340 ± 10 MPa	260 ± 10 MPa	255 ± 10 MPa	
12.	Elongation%	30% (Min)			
13.	Zinc Coating	450 g/ m ² (Min)			BS 443
14.	Galvanization	Hot Dip Galvanized No Copper deposition up to 4 th dip			
15.	Packing	Standard Packing as per latest instruction(s) by consignee			-
16.	Size Length				Measuring Tape
	a. Home Side	11.5 ft	-	-	
	b. For Side	13.5 ft	-	-	
	c. Quantity per Km	274 Nos each side	-	-	

RESTD
DRAWING - POLE 3 INCH

PRINT DATE - 10-02-2023

SEALED DC (P) NO	
AMENDMENTS	
DATE	REVISION

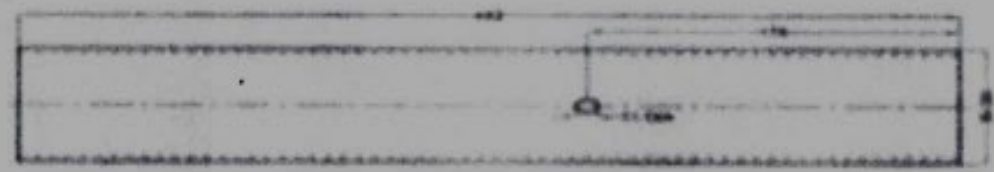

FRONT VIEW

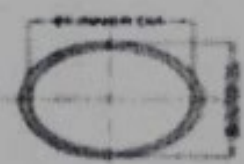

TOP VIEW

DIMENSIONS IN MM

ISO ANGLE PROJECTION	SCALE 1:1	ISO TO BS
DRG NO		
APPROVED BY		
STORES & LOGISTICS		

DATE	

TITLE - **FENCING MATERIAL**
POLE DIA 3"

RESTD

DRAWING - POLE 2 INCH

SEALED, D.C. (P) No.	
AMENDMENTS	
DATE	AUTHORITY

DRAFT DRG.

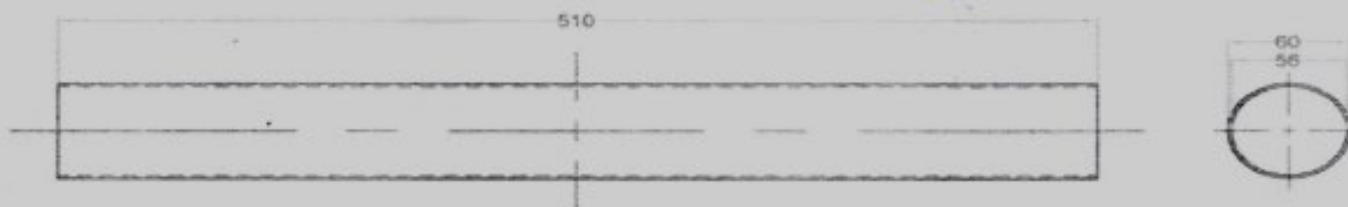

DIMENSIONS IN MM

3rd ANGLE PROJECTION	SCALE 1:2	NOT TO BE SCALED
----------------------	--------------	---------------------

DRAWN	M. UMAR (20/04/11)
TRACED	
CHECKED	S. QAMAR JAFRI
PASSED	
APPROVED	
DATE	

TITLE:-

**FENCING MATERIAL
POLE DIA 2" (FOR MAINT GATE)**

(THIS DRG. SHOULD BE READ IN CONJUNCTION WITH SEPARATE SPECIFICATION FOR THE SUBJECT STORE)

DRG. No.

INSPECTORATE OF ARMY
STORES & CLOTHING
KARACHI No 15

RESTD
DRAWING – POLE 1.5 INCH

PRINT DATE:-15-02-2022

SEALED D.C.(P)No. _____	
AMENDMENTS	
DATE	AUTHORITY

DRAFT DRG

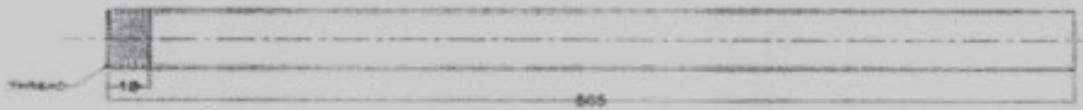

FRONT VIEW



TOP VIEW

DIMENSIONS IN MM

1st ANGLE PROJECTION	SCALE 1:2	NOT TO BE SCALED
----------------------	-----------	------------------

DRAWN	DESIGNED
CHECKED	
DATE	

TITLE:-

**FENCING MATERIAL
POLE DIA 1.5" X 1.5" (for Main Gate)**

DRG No

SUPERVISOR OF
APPLY STORES & EQUIPMENT
BANGALORE IS

(THIS DRG. SHD. BE READ IN CONJUNCTION WITH SEPARATE SPECIFICATION FOR THE SUBJECT STORE)

RESTD

Appendix 'C'

TECH DATA
ANGLE IRON

(Tech data is property of Govt of Pakistan and liable to amendments any time. It must be returned to Chief Inspector, Inspectorate of Army Stores and Clothing Karachi on Demand or immediately on completion the purpose for which it was issued)

Ser	Parameters	Specified Limits		Std Method
1.	Use	Fencing equipment for Border security		-
2.	Make, Shape and Design	As per approved sample and drawing		-
3.	Colour	Silver		-
4.	Angle iron	Used in Pole-V	Used in Gate	
	a. Gauge	6 SWG	12 SWG	SWG
	b. Thickness	4.877 mm (Min)	2.64 mm (Min)	-
	c. Material	Mild Steel	Mild Steel	ASTM E415
	d. Carbon%	≤ 0.12%		
	e. Size	1.5 x 1.5 inch	1 x 1 inch	Vernier Scale
	f. Hardness	90±2 HRB	88±2 HRB	ASTM 370/ ASTM E 18
	g. Tensile Strength	675±10 MPa	580±10 MPa	ASTM A 370
	h. Breaking Strength	570±10 MPa	465±10 MPa	
	i. Elongation%	29±1	24±1	
	j. Zinc Coating	380 g/ m ² (Min)	350 g/ m ² (Min)	BS 443:1982
	k. Galvanization	Hot Dip Galvanized No Copper deposition up to 4 th dip		BS 443:1982
5	Packing	Standard Packing as per latest instruction(s) by consignee		-

RESTD

DRAWING – ANGLE IRON 1.5 X 1.5 INCH

PRINT DATE: 15-02-2023

SEALED D.C (P) No	
AMENDMENTS	
DATE	AUTHORITY

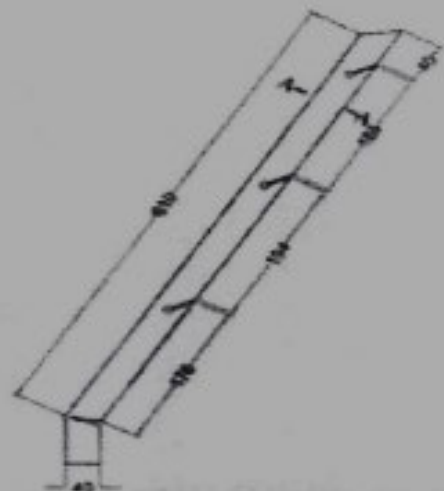

FRONT VIEW



SECTION A-A



SIDE VIEW

DRAFT DRG

DATE	ISSUED

TITLE -

**FENCING MATERIAL
ANGLE 1.5" X 1.5"**

(THIS DRAWING SHOULD BE READ IN CONJUNCTION WITH SEPARATE SPECIFICATION FOR THE SUBJECT WORK)

DIMENSIONS IN MM		
THE ANGLE PROJECTION	SCALE	NOT TO BE ENLARGED
	1:1	
DRG No		
REVISIONS OF DRAWING & REVISIONS PAGE NO		

RESTD

DRAWING - ANGLE IRON 1 X 1 INCH

PRINT DATE : 19-02-2022

SEALED D.C. (P) No

AMENDMENTS

DATE	BY	REASON

DRAFT DRG



DIMENSIONS IN MM

1st ANGLE PROJECTION	SCALE 1:1	NOT TO BE SCALED
----------------------	-----------	------------------

DESIGNED	DATE
CHECKED	
APPROVED	
DATE	

TITLE:-

**FENCING MATERIAL
ANGLE IRON 1" X 1" (FOR MAIN GATE)**

DRG. No.

ALWAYS STORAGE OF DRAWING
STORAGE & CLOSING
KARUNAKR 18

THIS DRG. SHOULD BE READ IN CONJUNCTION WITH SEPARATE SPECIFICATION FOR THIS DRAWING.

SECRET

POLE WITH V TYPE ANGLE IRON (11.5' & 13.5')

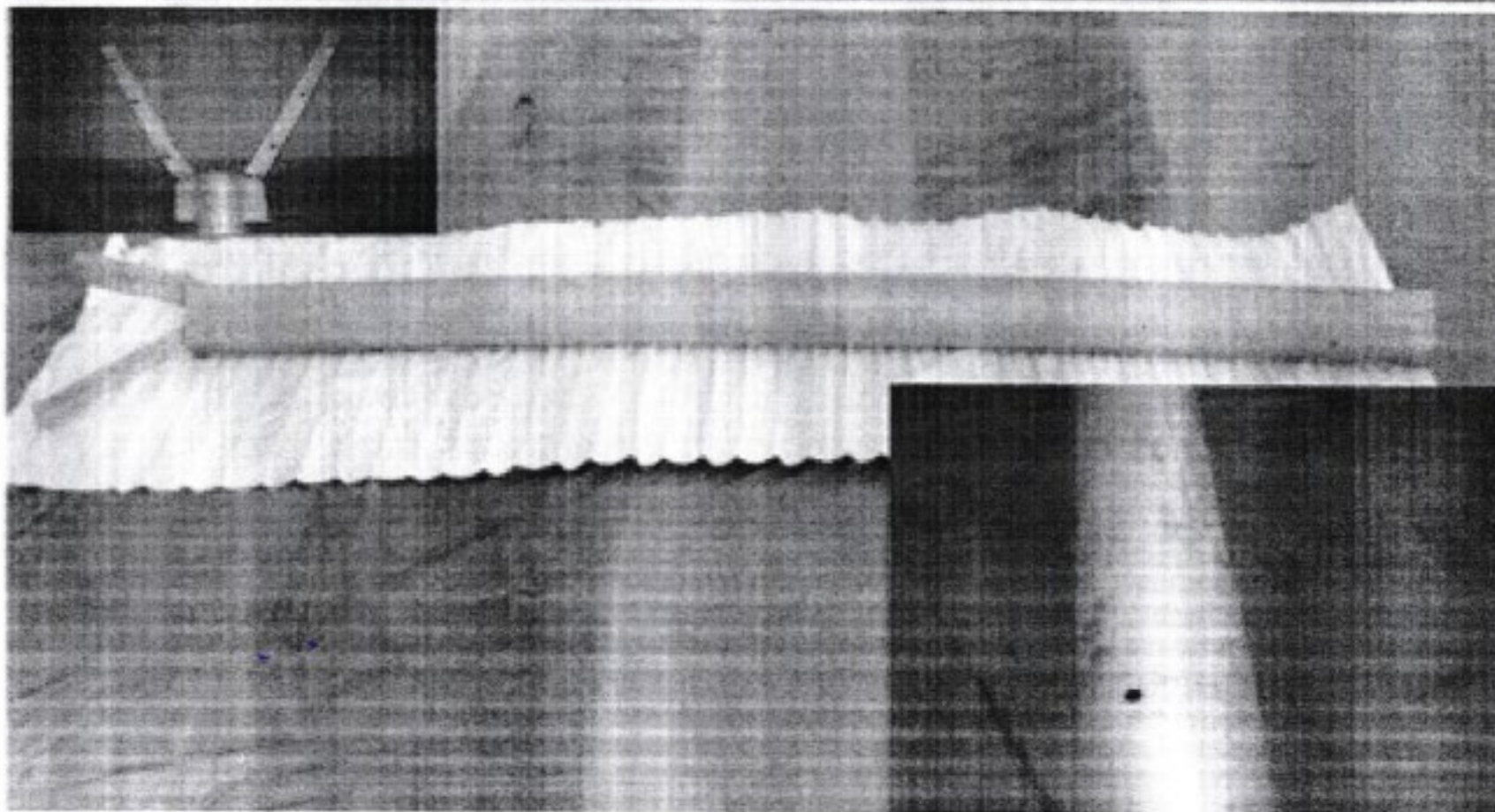

SECRET

GATE (H/S & F/S)

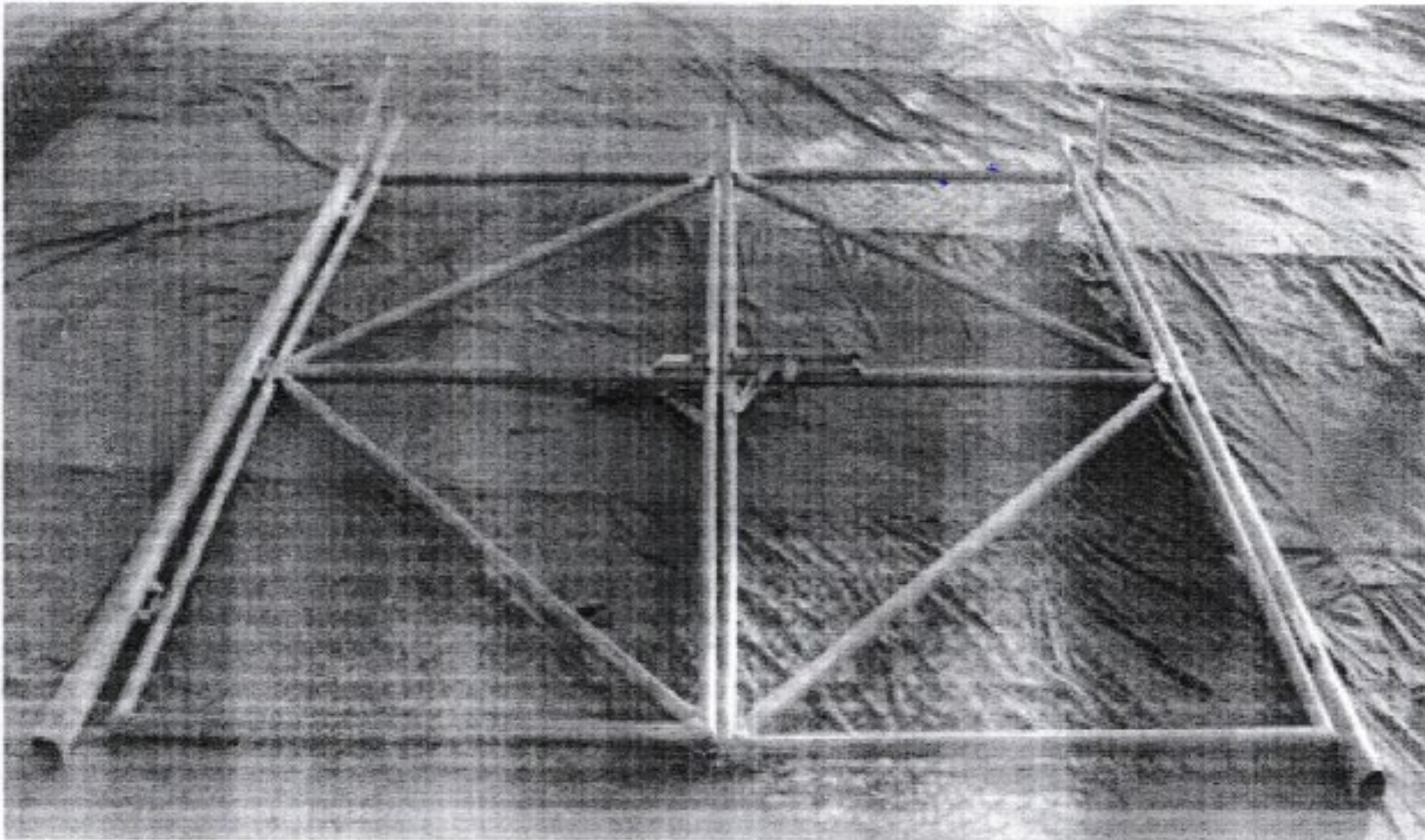

*(Tech data i
must be returned to
Demand or immediat*

Ser	
1.	Use
2.	Make, S
3.	Colour
4.	Mesh
5.	Poles
6.	Angle inc
7.	Packing
8.	Gate Siz
	a. Hom
	b. For S
	c. Quar

RESTD

Appendix 'E'

TECH DATA

POLE

(Tech data is property of Govt of Pakistan and liable to amendments any time. It must be returned to Chief Inspector, Inspectorate of Army Stores and Clothing Karachi on Demand or immediately on completion the purpose for which it was issued)



Ser	Parameters	Specified Limits
1.	Use	-
2.	Make, Shape and Design	-
3.	Colour	-
4.	Poles	Std as per tech data Appendix 'B'
5.	Angle iron	Std as per tech data Appendix 'C'
6.	Packing	-
7.	Quantity per Km	1096 Nos

RESTD
DRAWING - POLE V

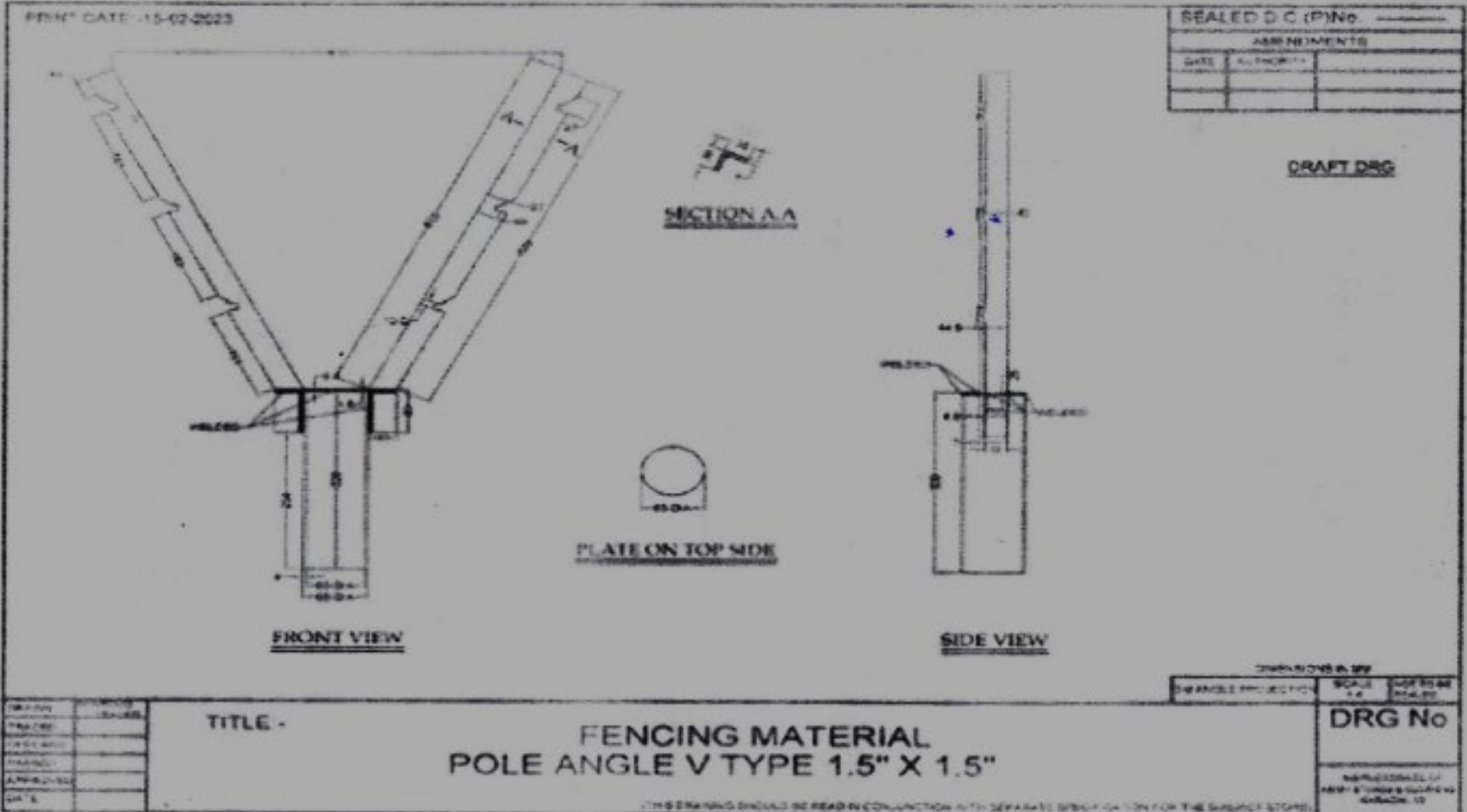

TECH DATA
SHORT PICKET

(Tech data is property of Govt of Pakistan and liable to amendments any time. It must be returned to Chief Inspector, Inspectorate of Army Stores and Clothing Karachi on Demand or immediately on completion the purpose for which it was issued)

Ser	Parameters	Specified Limits	Std Method
1.	Use	Fencing equipment for Border security	-
2.	Make, Shape and Design	As per approved sample and drawing	-
3.	Colour	Silver	-
4.	Gauge	5 SWG	SWG
5.	Thickness	5.385mm	Micrometer
6.	Hardness	90±2 HRB	ASTM 370/ ASTM E 18
7.	Material	Mild Steel	ASTM E 415
8.	Carbon%	≤ 0.12%	
9.	Tensile strength	675 ± 10 MPa	ASTM 370
10.	Breaking Strength	570± 10 MPa	
11.	Elongation%	29± 1 %	
12.	Zinc Coating (g/ m ²)	350 g/ m ² (Min)	BS 443:1982
13.	Galvanization	Hot Dip Galvanized No Copper deposition up to 4 th dip	
14.	Packing	Standard Packing as per latest instruction(s) by consignee	-
15.	Size/ dimension	2 x 2 x 27 inch	Measuring Tape
16.	Quantity per Km	132 Nos	-

RESTD
DRAWING - SHORT PICKET

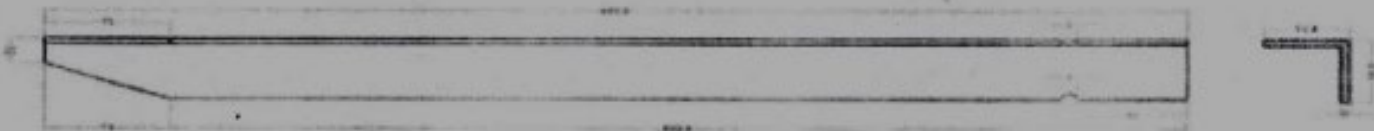
		SEALED D.C. (P) No.	
		REVISIONS	
		DATE	BY
<u>DRAFT DRG.</u>			
			
DIMENSIONS IN MM			
	DRAWN BY	SCALE	DATE
TITLE:-		<p>FENCING MATERIAL PICKET HOT DIP GALVANIZED 2"X2"X27"</p>	
		<p>DRG. No.</p> <p>INSPECTORATE OF CAMP STATION & DIST. TRAINING WARANGAL-50</p>	
THIS DRAWING SHOULD BE READ IN CONJUNCTION WITH SEPARATE SPECIFICATION ATTACHED TO IT.			

SHORT PICKET 2"

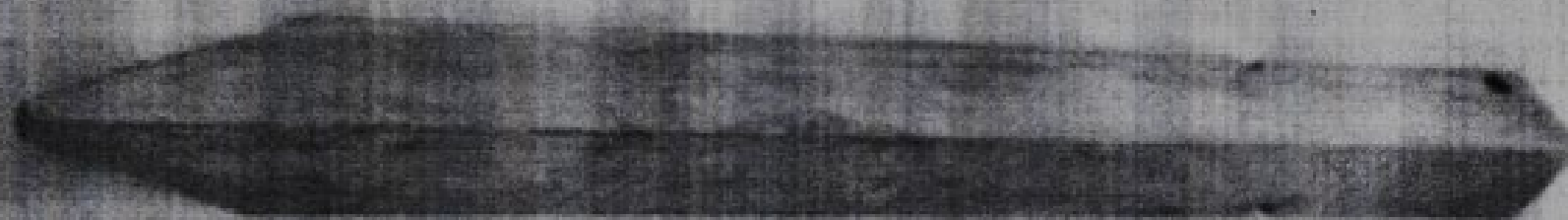

TECH DATA
STEEL CLAMP

(Tech data is property of Govt of Pakistan and liable to amendments any time. It must be returned to Chief Inspector, Inspectorate of Army Stores and Clothing Karachi on Demand or immediately on completion the purpose for which it was issued)

Ser	Parameters	Specified Limits	Std Method
1.	Use	Fencing equipment for Border security	-
2.	Make, Shape and Design	As per approved sample and drawing	-
3.	Colour	Silver	-
4.	Clamp Main Sleeve/ Strip		
	a. Gauge	16 SWG	SWG
	b. Dia	3.5 inch	
	c. Thickness	1.5mm (Min)	Micrometer
	d. Hardness	48±3 HRB	EN ISO 6508
	e. Material	Mild Steel	ASTM E 415
	f. Carbon %	≤ 0.2%	
	g. Zinc Coating	70 g/m ² (Min)	BS 443:1982
	h. Galvanization	Hot Dip Galvanized No Copper deposition up to 2 nd dip	BS 443:1982
5.	Nut & Bolt Material		
	a. Material	Mild Steel	ASTM E 415
	b. Zinc Coating	70 g/m ² (Min)	BS 443:1982
	c. Galvanization	Hot Dip Galvanized No Copper deposition up to 2 nd dip	BS 443:1982
6.	Packing	Standard Packing as per latest instruction(s) by consignee	-
7.	Quantity per Km	2550 Nos	

RESTD

DRAWING - STEEL CLAMP

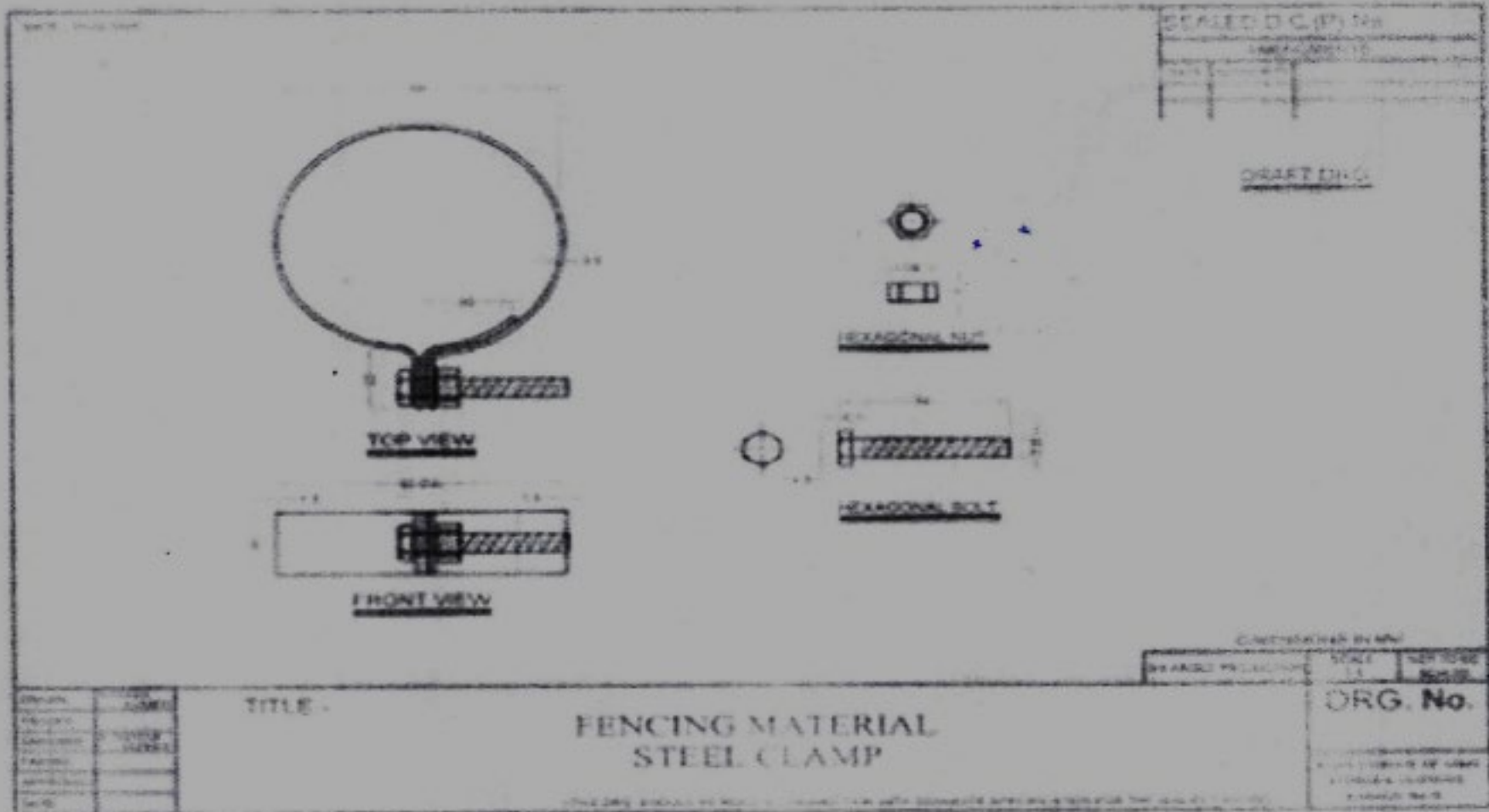

TECH DATA**HOOK**

(Tech data is property of Govt of Pakistan and liable to amendments any time. It must be returned to Chief Inspector, Inspectorate of Army Stores and Clothing Karachi on Demand or immediately on completion the purpose for which it was issued)

Ser	Parameters	Specified Limits	Std Method
1.	Use	Fencing equipment for Border security	-
2.	Make, Shape and Design	As per approved sample and drawing	-
3.	Colour	Silver	-
4.	Length	24 inch	Measuring tape
5.	Dia	0.5 inch	Vernier Caliper
6.	Material	Mild Steel	ASTM E 415
7.	Carbon%	≤ 0.2%	
8.	Galvanization	Hot Dip Galvanized No Copper deposition up to 4 th dip	BS 443:1982
9.	Zinc Coating	160 g/m ² (Min)	BS 443:1982
10.	Packing	Standard Packing as per latest instruction(s) by consignee	-
11.	Quantity per Km	3550 Nos	-

RESTD
DRAWING - HOOK

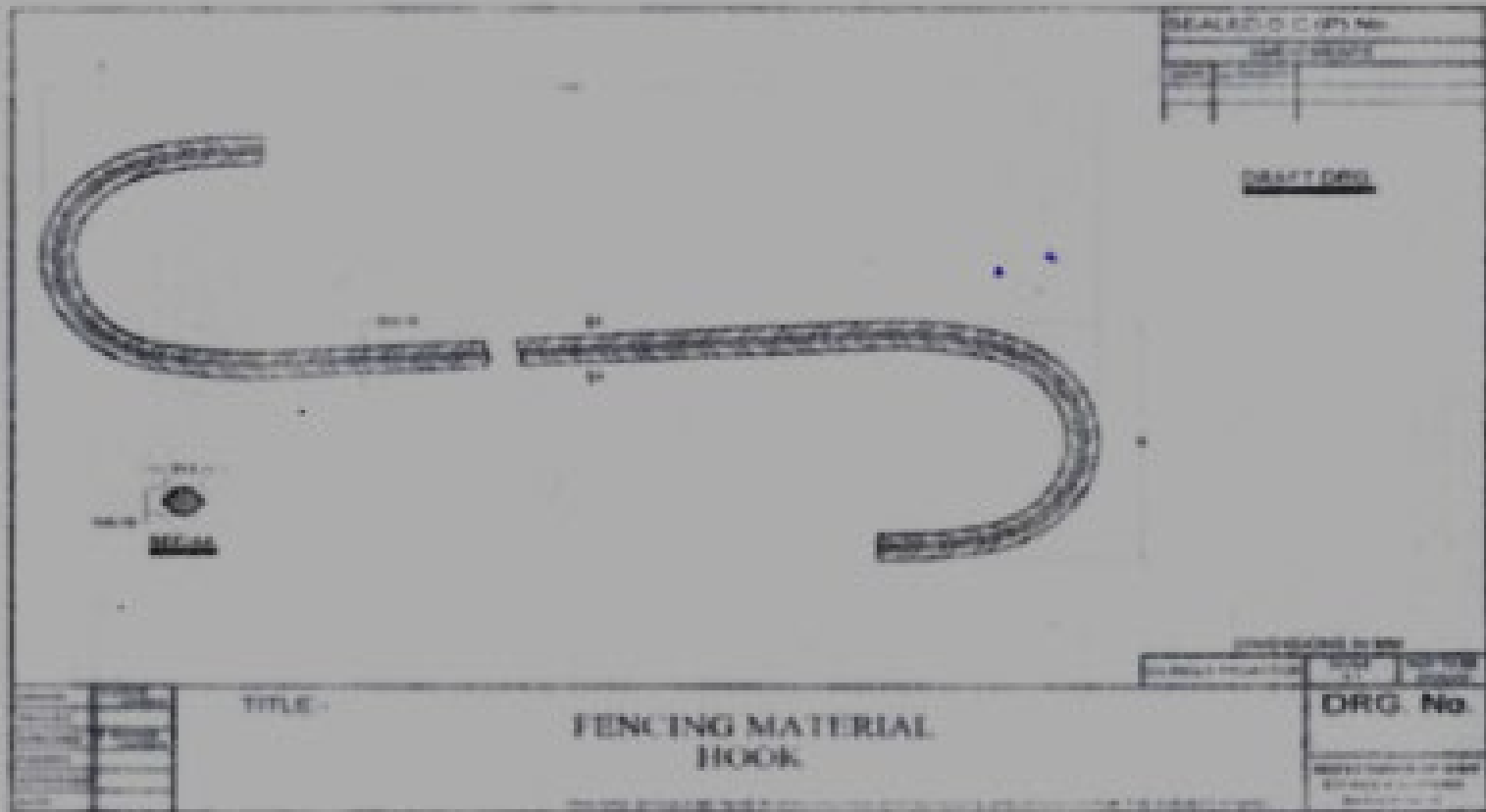

DESIGNED BY: C. C. (P) No.	
DATE: / /	
SCALE:	
DATE:	

DRAWN BY:



CHECKED BY: / /	
DATE:	
DRG. No.	
REVISED BY: / /	
DATE:	

TITLE - **FENCING MATERIAL HOOK**

MESH HOOK

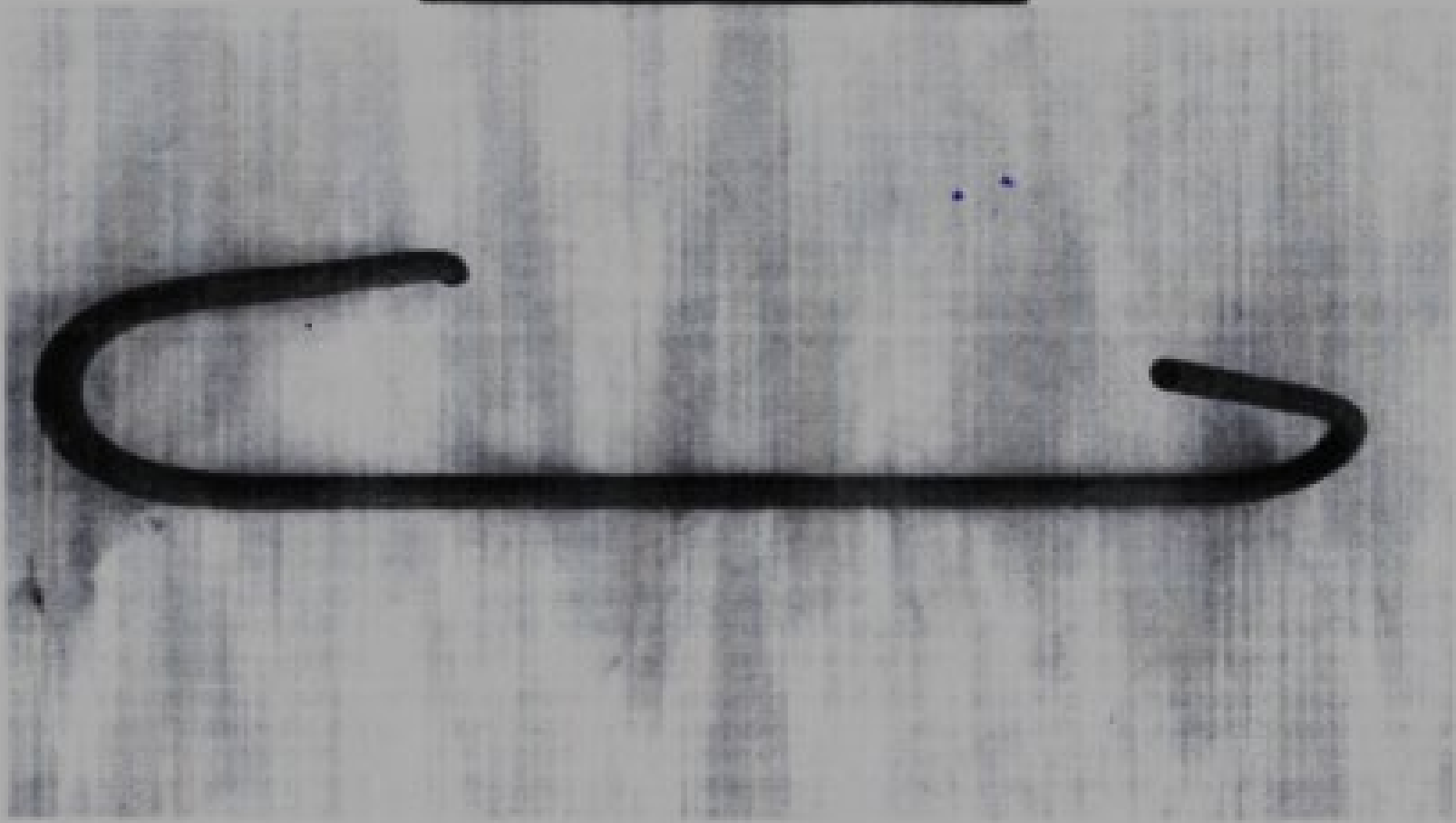

TECH DATA**JOINT CLIP**

(Tech data is property of Govt of Pakistan and liable to amendments any time. It must be returned to Chief Inspector, Inspectorate of Army Stores and Clothing Karachi on Demand or immediately on completion the purpose for which it was issued)

Ser	Parameters	Specified Limits	Std Method
1.	Use	Fencing equipment for Border security	-
2.	Make, Shape and Design	As per approved sample and drawing	-
3.	Colour	Silver	-
4.	Gauge	18 SWG	SWG
5.	Thickness	1.118 mm	Micrometer
6.	Material	Mild Steel	ASTM E 415
7.	Carbon%	≤0.2%	
8.	Galvanization	Hot Dip Galvanized No Copper deposition up to 2 nd dip	BS 443:1982
9.	Zinc Coating	70 g/ m ² (Min)	BS 443:1982
10.	Packing	Standard Packing as per latest instruction(s) by consignee	-
11.	Quantity per Km	60 Kg	

DRAWING - JT CLAMP

PART No. _____ QTY _____ DATE _____	UNIFIED D.C.C.P. No. _____ AMENDMENTS NO. _____ DATE _____ DRAFT DRG
-------------------------------------------	--------------------------------------------------------------------------------------

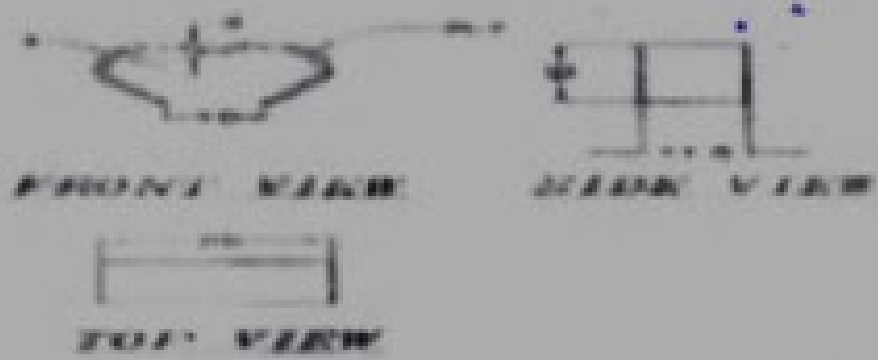

DESIGNED DRAWN CHECKED APPROVED DATE	APPROVED DATE	DIMENSIONS IN MM (AND SMALL FRACTIONS) 1/16" 1/32" 1/64"	DRG No. _____
		TITLE FINISH MATERIAL JT CLIP	APPROVED BY _____ OFFICE & SIGNATURE DATE _____

SECRET

BINDING CLAMP

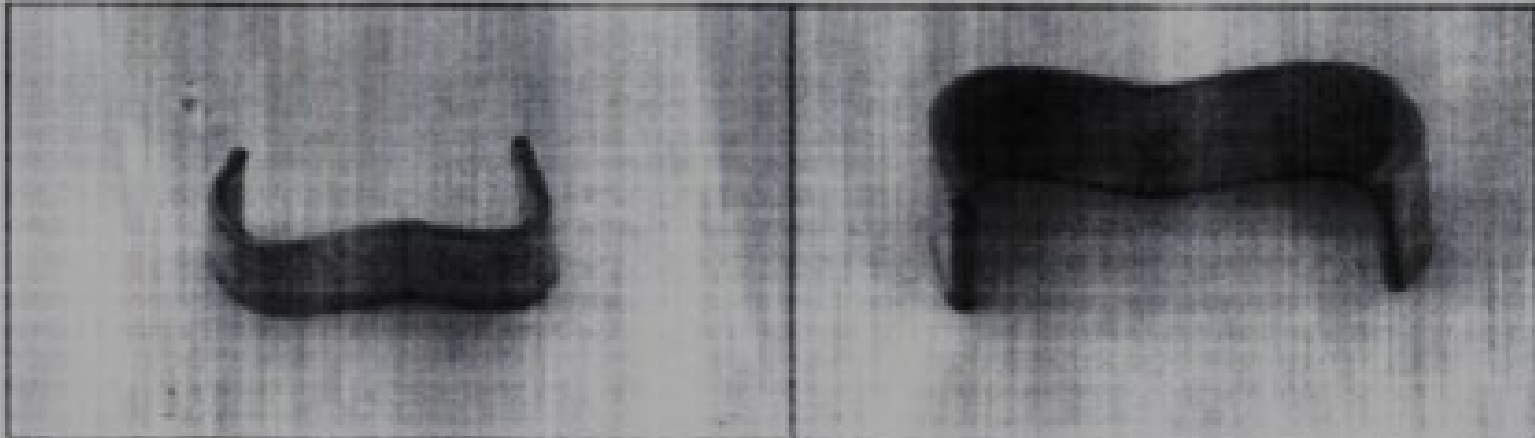
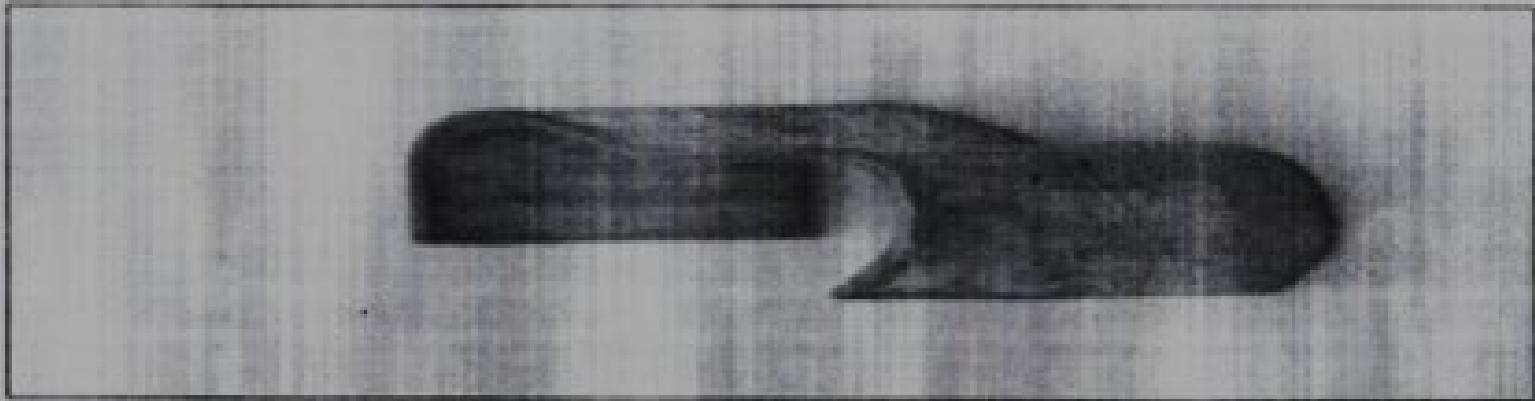

TECH DATA

SWS

(Tech data is property of Govt of Pakistan and liable to amendments any time. It must be returned to Chief Inspector, Inspectorate of Army Stores and Clothing Karachi on Demand or immediately on completion the purpose for which it was issued)

Ser	Parameters	Specified Limits	Std Method
1.	Use	Fencing equipment for Border security	-
2.	Make, Shape and Design	As per approved sample and drawing	-
3.	Colour	Silver	-
4.	Wire Dia	4±0.1 mm	Micrometer
5.	No of strand in Wire	19 Nos	Manually Counted
6.	Strand wire dia (each)	0.914±0.01 mm	Micrometer
7.	Material	Mild Steel	ASTM E 415
8.	Galvanization	Hot Dip Galvanized No Copper deposition up to 4 th dip	BS 443:1982
9.	Zinc Coating	180 g/ m ² (Min)	BS 443:1982
10.	Packing	Standard Packing as per latest instruction(s) by consignee	-
11.	Quantity per Km	11000ft	-

DRAWING - SWR

PRINT DATE: 11-02-2023

SCALED D.C. (P) No.	
APPROVED:	
DATE:	BY:

DRAFT DRG.



DIMENSIONS IN MM

IN SCALE PROJECTION	SCALE 1:1	NOT TO BE SCALE
---------------------	--------------	--------------------

DESIGN	BY: / DATE:
DESIGNED	
CHECKED	
APPROVED	
DATE	

TITLE:-

**FENCING MATERIAL
SWG SWR**

DRG. No.

REPLACE THIS BY JUNE
STANDARD & CLIPPING
DRAWING NO. 10

THIS DRAWING IS TO BE USED ONLY FOR THE PURPOSES SPECIFIED IN THE SUBJECT & NOT FOR ANY OTHER PURPOSES.

TOP SWR



TECH DATA

DT CLAMP

(Tech data is property of Govt of Pakistan and liable to amendments any time. It must be returned to Chief Inspector, Inspectorate of Army Stores and Clothing Karachi on Demand or immediately on completion the purpose for which it was issued)

Ser	Parameters	Specified Limits	Std Method
1.	Use	Fencing equipment for Border security	-
2.	Make, Shape and Design	As per approved sample and drawing	-
3.	Colour	Silver	-
4.	Clamp Size No	10	-
5.	Clamp Housing / Basic casted bridge with Nut& Bolt		
	a. Material	Mild Steel	ASTM E 415
	b. Carbon%	≤ 0.2%	
	c. Zinc Coating	160 g/ m ² (Min)	BS 443:1962
	d. Galvanization	Hot Dip Galvanized No Copper deposition up to 4 th dip	BS 443:1962
6.	Packing	Standard Packing as per latest instruction(s) by consignee	-
7.	Quantity per Km	500 Nos	-

RESTD

DRAWING - DT CLAMP

PROJECT NO. / FILE NO.

SEALED D/C (P) No	
AMENDMENTS	
DATE	AUTHORITY

DRAFT DRG

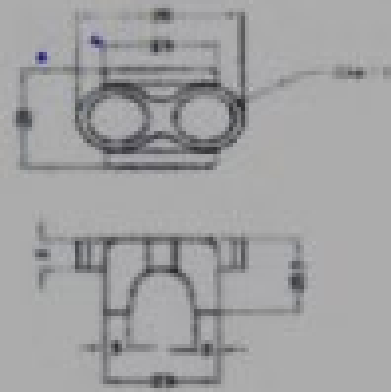

PARTS DETAIL DT CLAMP

EXEMPTED BY DRG

DRG NO.	SCALE	DATE

DATE	A. H. SINGH

TITLE -

**FENCING MATERIAL
DT CLAMP**

DRG No

THIS DRAWING SHOULD BE READ IN CONJUNCTION WITH THE RELEVANT SPECIFICATIONS FOR THE SUBJECT & TYPE.

APPROVED BY DRG
DATE

DT CLAMP 6 mm



TECH DATA**RAZOR WIRE COIL 18 INCH**

(Tech data is property of Govt of Pakistan and liable to amendments any time. It must be returned to Chief Inspector, Inspectorate of Army Stores and Clothing Karachi on Demand or immediately on completion the purpose for which it was issued)

Ser	Parameters	Specified Limits	Std Method
1.	Use	Fencing equipment for Border security	-
2.	Make, Shape and Design	As per approved sample and drawing	-
3.	Colour	Silver	-
4.	Line Wire		
	a. Coil Dia	18 inch	Measuring Tape
	b. Wire Dia	3.25±0.05mm	Micrometer
	c. Gauge	10 SWG	SWG
	d. Material	Mild Steel	ASTM E415
	e. Carbon%	≤ 0.12%	
	f. Tensile Strength	870 ±10 MPa	ASTM 370
	g. Breaking Load	615 ±10 MPa	
	h. Elongation%	13 ±1%	-
	i. Zinc Coating	200 g/ m ² (Min)	BS 443
	j. Galvanization	Hot Dip Galvanized No Copper Deposition up to 4 th dips	
5.	Razor		
	a. Material	Mild Steel	ASTM E415
	b. Carbon%	≤ 0.12%	
	c. Thickness	0.50 ± 0.05mm	Micrometer
	d. Distance between Razor	25 ± 0.5 mm	Measuring scale
	e. Tensile Str (sheet)	430±10 MPa	BS 443 : 1982/ ASTM A 90
	f. Zinc Coating	200 g/ m ² (Min)	
	g. Galvanization	Hot Dip Galvanized No Copper Deposition up to 4 dips	BS 443 : 1982
6.	Packing	Standard Packing as per latest instruction(s) by consignee	-
7.	Quantity per Km	3.8 Ton	-

TECH DATA**RAZOR WIRE COIL 36 INCH**

(Tech data is property of Govt of Pakistan and liable to amendments any time. It must be returned to Chief Inspector, Inspectorate of Army Stores and Clothing Karachi on Demand or immediately on completion the purpose for which it was issued)

Ser	Parameters	Specified Limits	Std Method
1.	Use	Fencing equipment for Border security	-
2.	Make, Shape and Design	As per approved sample and drawing	-
3.	Colour	Silver	-
4.	Line Wire		
	a. Coil Dia	36inch	Measuring Tape
	b. Wire Dia	3.25 ±0.05mm	Micrometer
	c. Gauge	10 SWG	SWG
	d. Material	Mild Steel	ASTM E415
	e. Carbon%	≤ 0.12%	
	f. Tensile Strength	870 ±10 MPa	ASTM 370
	g. Breaking Load	615 ±10 MPa	
	h. Elongation%	13 ±1%	BS 443
	i. Zinc Coating	200 g/ m ² (Min)	
	j. Galvanization	Hot Dip Galvanized No Copper Deposition up to 4 th dips	
5.	Razor		
	a. Material	Mild Steel	ASTM E415
	b. Carbon%	≤ 0.12%	
	c. Thickness	0.50 ± 0.05mm	Micrometer
	d. Distance between Razor	25 ± 0.5 mm	Measuring scale
	e. Tensile Str (sheet)	430±10 MPa	BS 443 : 1982/ ASTM A 90
	f. Zinc Coating	200 g/ m ² (Min)	
	g. Galvanization	Hot Dip Galvanized No Copper Deposition up to 4 dips	
6.	Packing	Standard Packing as per latest instruction(s) by consignee	-
7.	Quantity per Km	16 ton	-

RESIN

DRAWING - RAZOR WIRE COIL 36 INCH

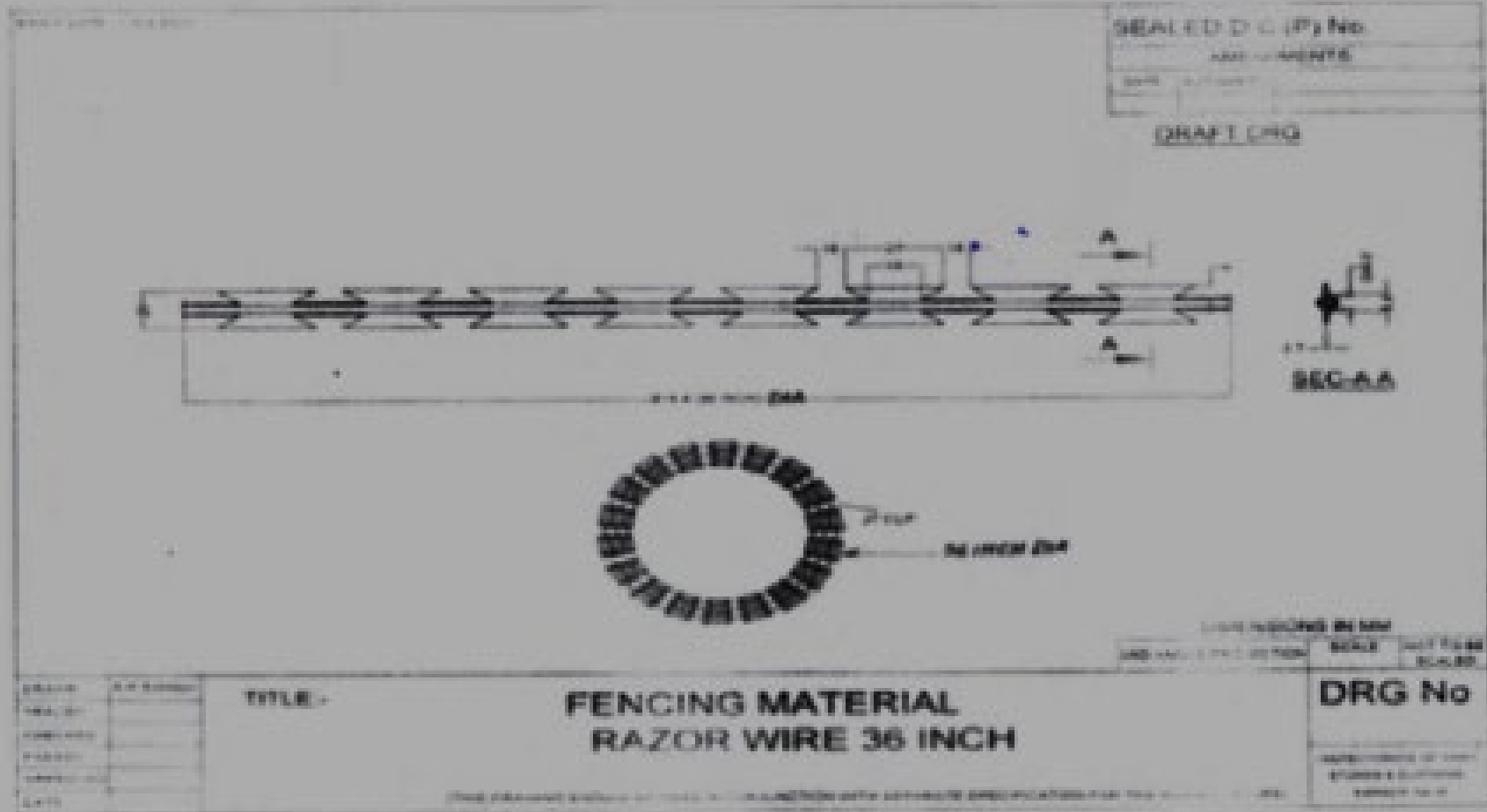

DRAWING - RAZOR WIRE COIL 18 INCH

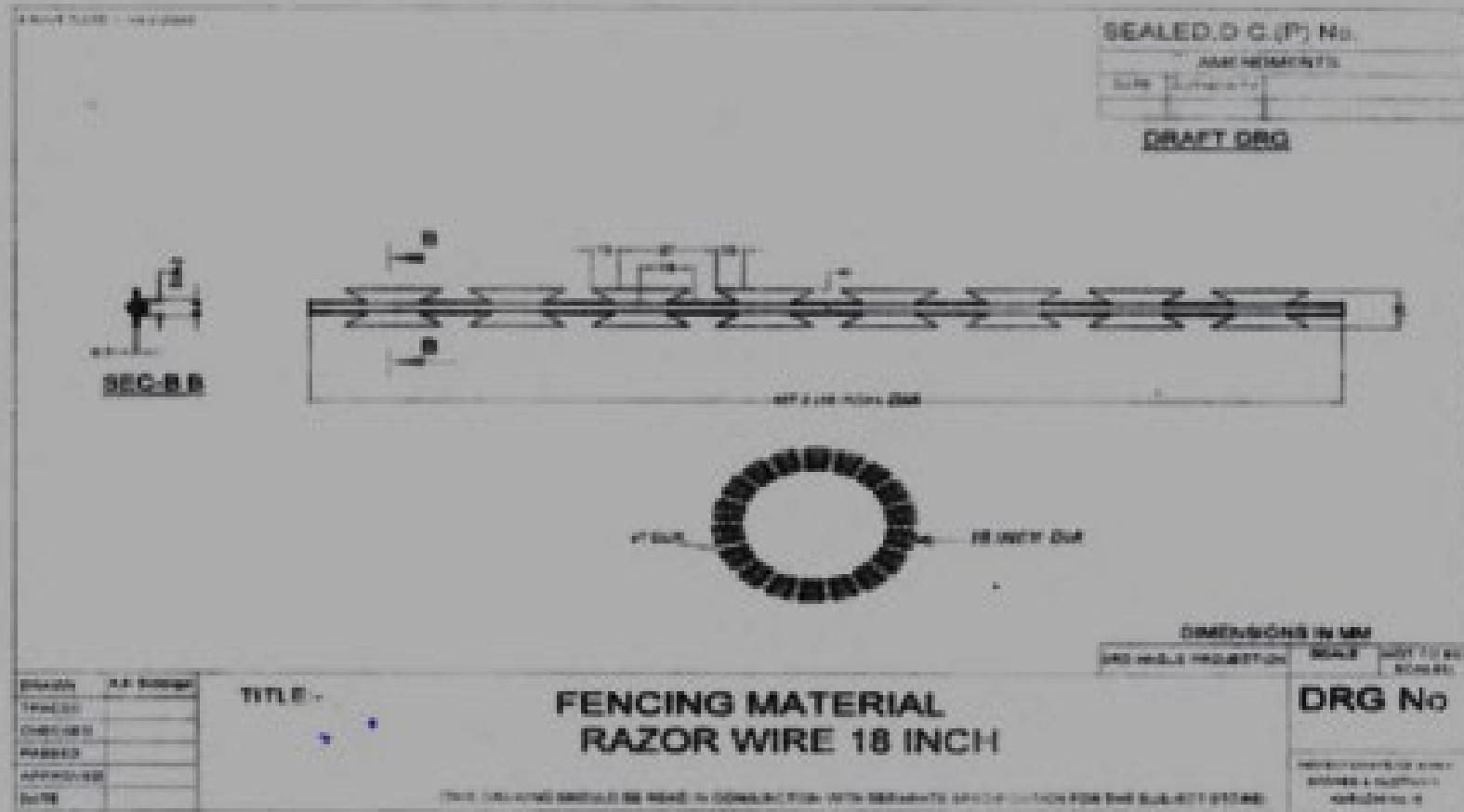

SEALED O.G. (P) No. _____
 AND REMARKS _____
 DATE _____
DRAFT DRG.

DESIGN	A.P. DESIGN
DESIGNED	
CHECKED	
DRAWN	
APPROVED	
DATE	

TITLE -

FENCING MATERIAL RAZOR WIRE 18 INCH

DIMENSIONS IN MM
 1/8 INCH THICKNESS SCALE 1:10 BY SCALE

DRG No

THIS DRAWING SHOULD BE READ IN CONJUNCTION WITH SEPARATE SPECIFICATION FOR THE SUBJECT ITEM.

REVISIONS AND
 CHANGES
 SHOULD BE
 INDICATED

RAZOR COIL (18" & 36")

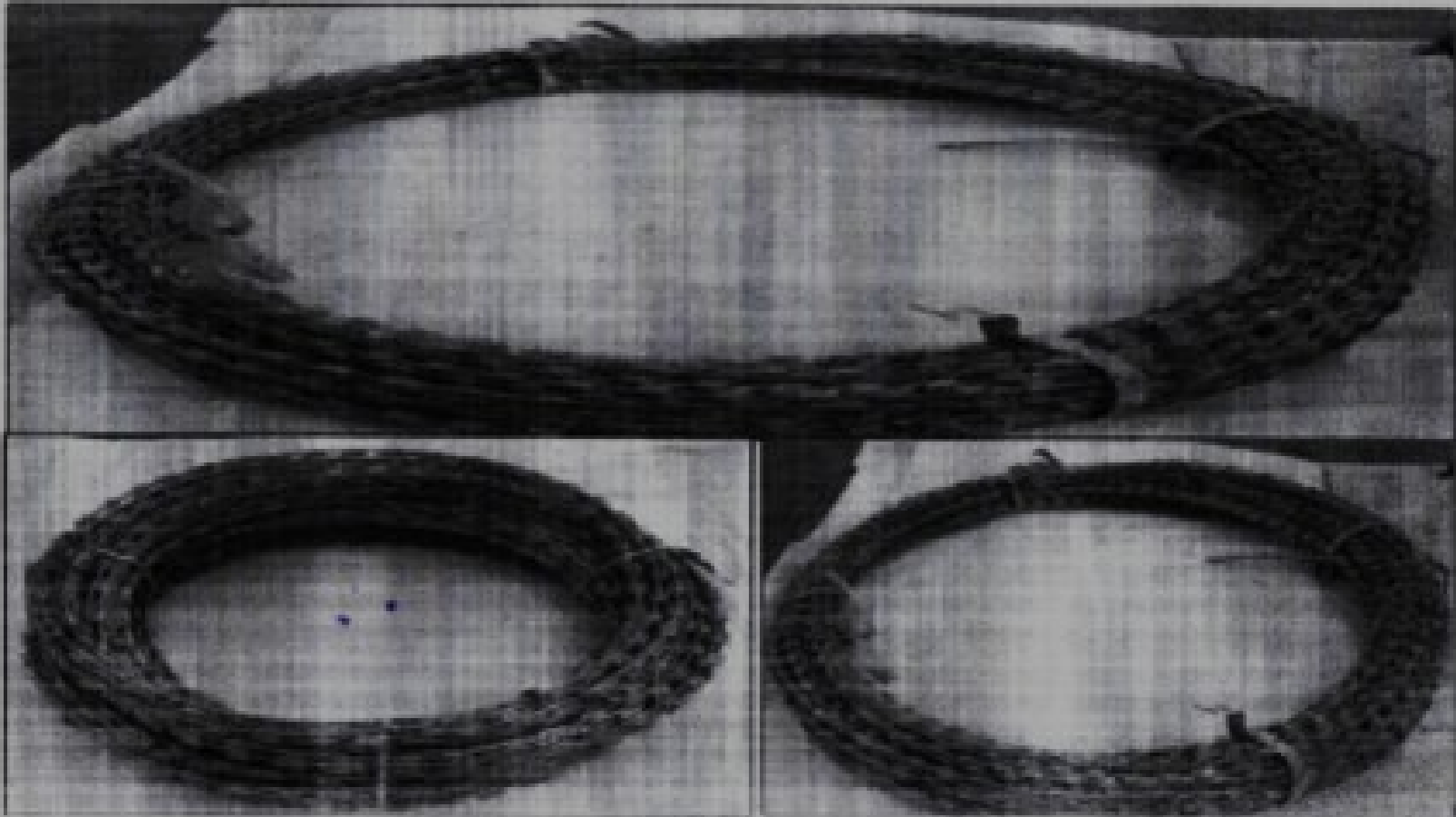

TECH DATA BARBED WIRE

(Tech data is property of Govt of Pakistan and liable to amendments any time. It must be returned to Chief Inspector, Inspectorate of Army Stores and Clothing Karachi on Demand or immediately on completion the purpose for which it was issued.)

Ser	Parameters	Specified Limits	Std Method
1.	Use	Fencing equipment for Border security	-
2.	Make, Shape and Design	As per approved sample and drawing	-
3.	Colour	Silver	-
4.	Line Wire		
	a. Wire Dia	2.642 ± 0.1mm	Micrometer
	b. Gauge	12 SWG	SWG
	c. Material	Mild Steel	ASTM E415
	d. Carbon%	≤ 0.12%	
	e. Tensile Strength	420 ± 10MPa	ASTM 370/ ISO 6892-1
	f. Breaking Load	220 ± 10MPa	
	g. Elongation%	18±1 %	-
	h. Zinc Coating	245 g/ m ² (Min)	Class 3 ASTM A 121
	i. Galvanization	Hot Dip Galvanized No Copper Deposition up to 4 dips	BS 443 : 1982
5.	Barb / spike		
	a. Material	Mild Steel	ASTM E415
	b. Carbon%	≤ 0.12%	
	c. Gauge	12 SWG	SWG
	d. Dia of Barb wire	2.642 ± 0.1mm	Micrometer
	e. Distance between spike	100 ±5mm	Measuring scale
	f. Tensile Strength	420 ± 10MPa	ASTM 370/ ISO 6892-1
	g. Breaking Load	220 ± 10MPa	
	h. Elongation%	18 ±1 %	-
	i. Zinc Coating	245 g/ m ² (Min)	BS 443 : 1982
	j. Galvanization	Hot Dip Galvanized No Copper Deposition up to 4 dips	
6.	Packing	Standard Packing as per latest instruction(s) by consignee	-
7.	Quantity per Km	2.2 Ton	

DRAWING - BARBED WIRE

PREP. DATE: 15/08/2008		REALE D. C. (P) No. _____ _____ _____	
		DRAFT ORG. 	
TITLE:		FENCING MATERIAL BARBED WIRE	
_____ _____ _____		ORG. No. _____ _____ _____	

BARBED WIRE



WARNING BOARDS

(Tech data is property of Govt of Pakistan and liable to amendments any time. It must be returned to Chief Inspector, Inspectorate of Army Stores and Clothing Karachi on Demand or immediately on completion the purpose for which it was issued)

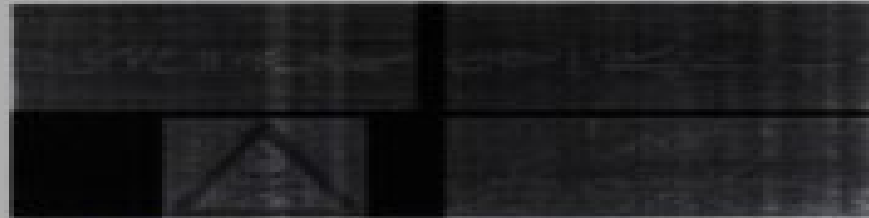

Ser	Parameters	Specified Limits	Std Method
1.	Use	Fencing equipment for Border security	-
2.	Make, Shape and Design	As per approved sample and drawing	-
3.	Plain Sheet		
	a. Gauge	14 SWG	SWG
	b. Material	Mid Steel with Carbon \leq 0.2%	ASTM E415
	c. Galvanization	Hot Dip Galvanized No Copper Deposition up to 4 dips	BS 443: 1982
4.	Background	Red/ Green/ Blue Lamination Sheet with Reflection property	-
5.	Text and Border	White colour Laminated sticker with reflection property	-
6.	Adhesive for lamination sheet	Best quality trade mark	-
7.	Packing	Standard Packing as per latest instruction(s) by consignee	-
8.	Quantity per Km	4 board at the distance of 700 Meters apart	-

RESTD

DRAWING - WARNING BOARDS

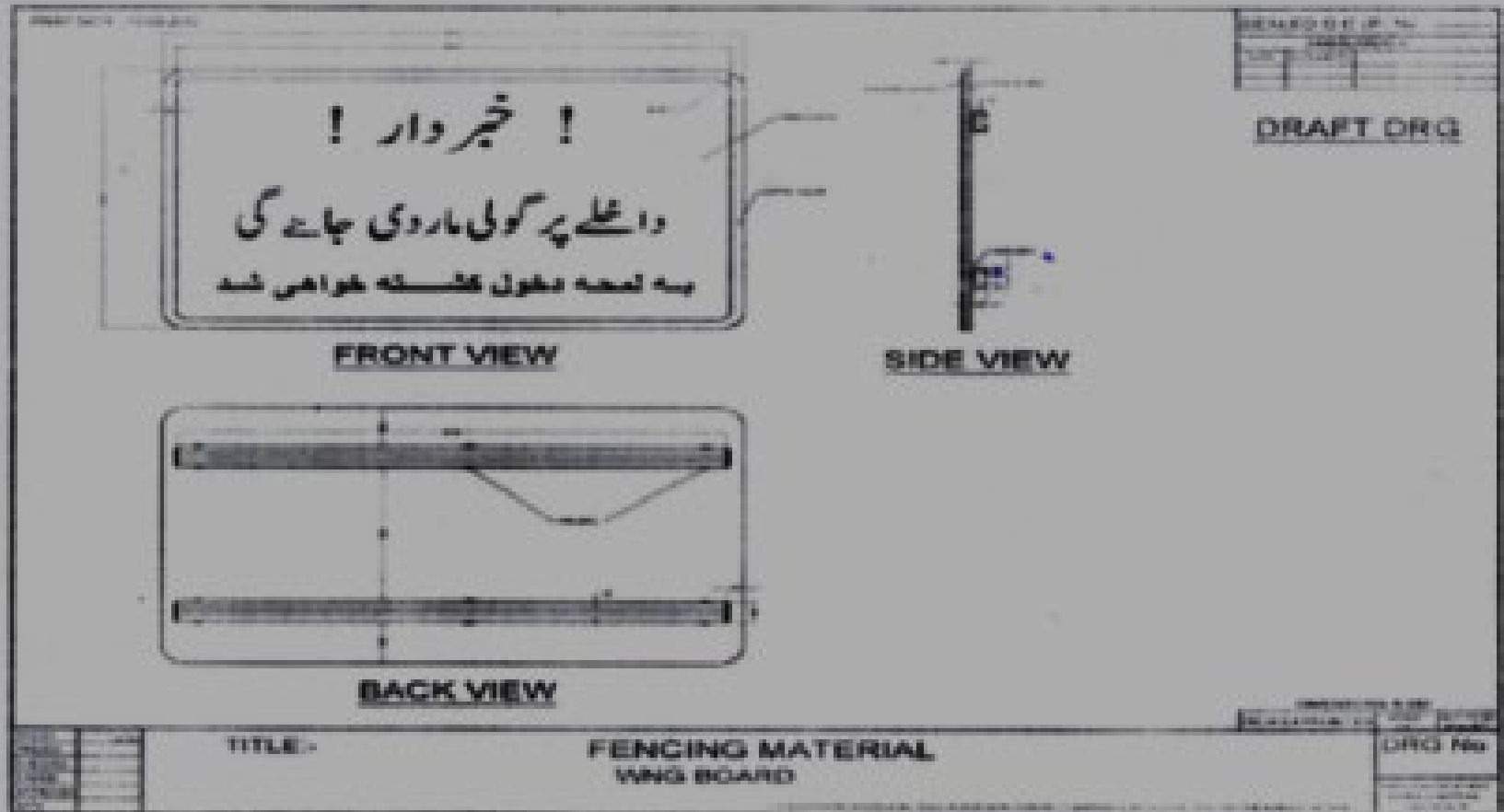

RESTD

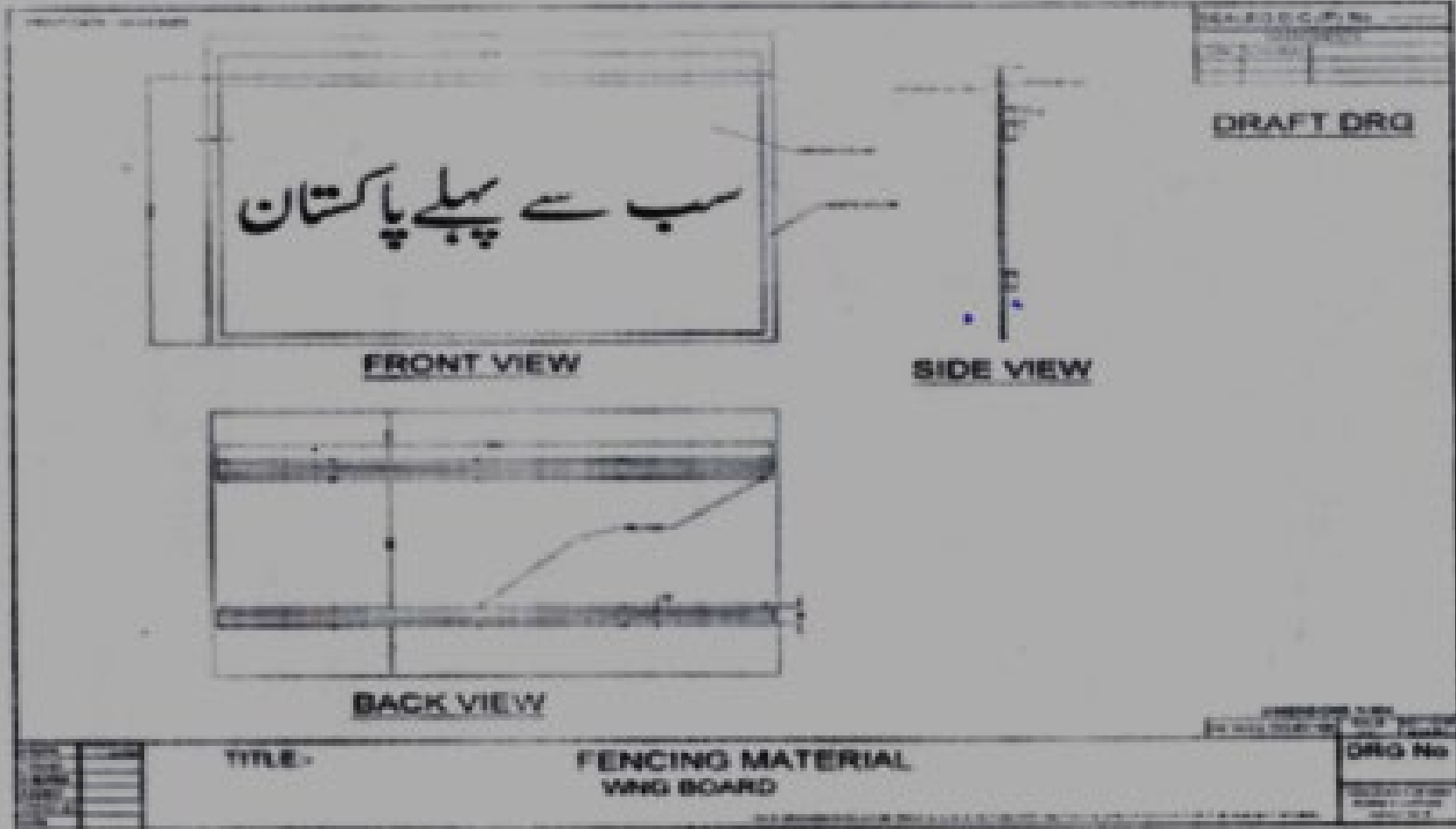

سب سے پہلے پاکستان

FRONT VIEW

SIDE VIEW

BACK VIEW

TITLE:-

FENCING MATERIAL
WING BOARD

ORG No

DRAFT DRG

RESTO

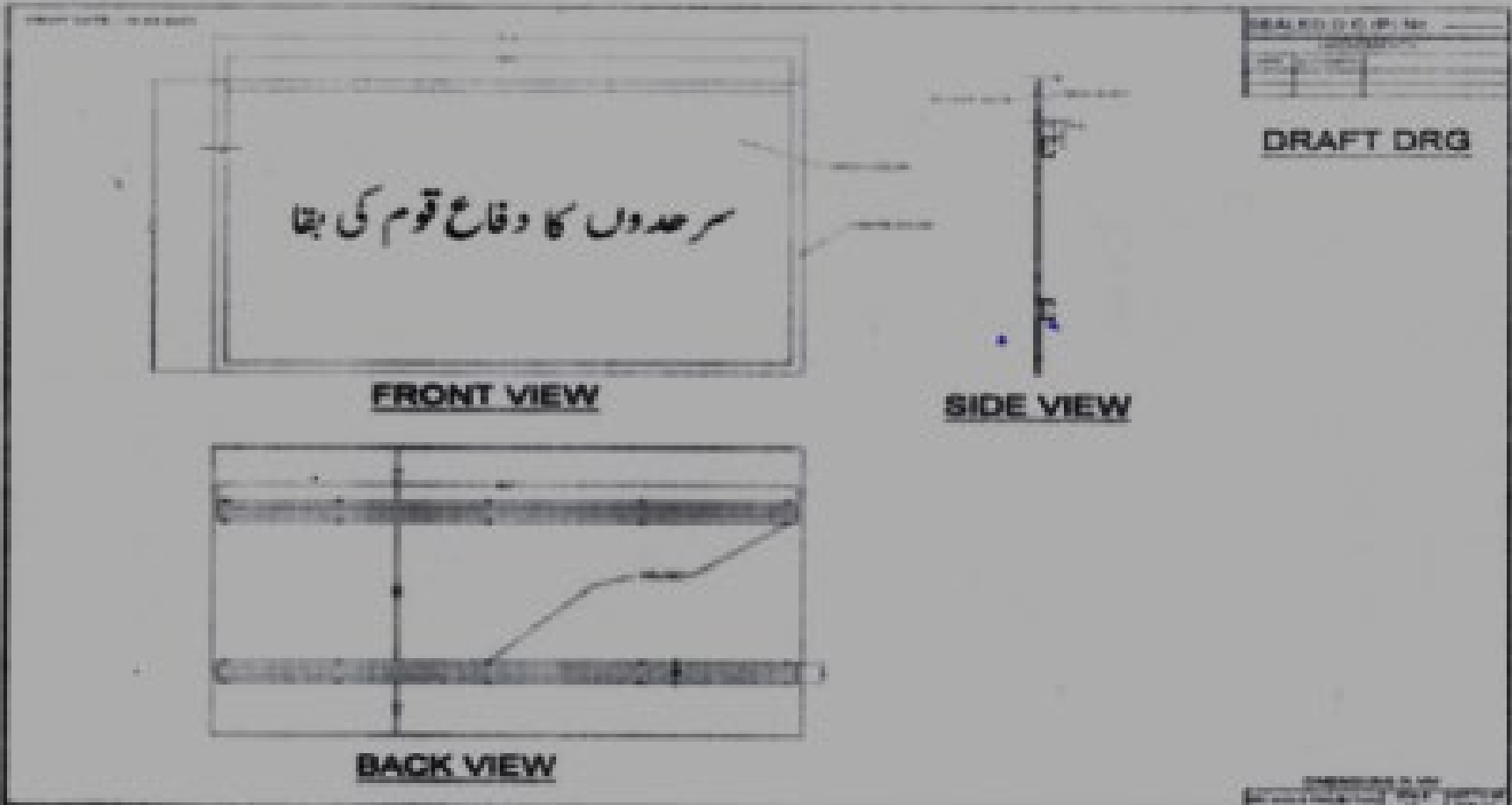

DATE	
SCALE	
BY	
CHECKED	
APPROVED	
DATE	

TITLE -

**FENCING MATERIAL
WING BOARD**

DRG No

DATE

WARNING BOARD

! خبردار !
داخلے پر گولی مار دی جائے گی
یہ داخلیدو بیہ بہ گولے اویشتلے شے

SIGN BOARD



DANGER BOARD



TECH DATA**BINDING WIRE**

(Tech data is property of Govt of Pakistan and liable to amendments any time. It must be returned to Chief Inspector, Inspectorate of Army Stores and Clothing Karachi on Demand or immediately on completion the purpose for which it was issued)

Ser	Parameters	Specified Limits	Std Method
1.	Use	Fencing equipment for Border security	-
2.	Make, Shape and Design	As per approved sample and drawing	-
3.	Colour	Silver	-
4.	Gauge	16	SWG
5.	Dia	1.62mm	Vernier Caliper
6.	Material	Mild Steel with medium carbon steel	ASTM E 415
7.	Type	Annealed	BS-1052
8.	Finish	Electroplating	-
9.	Tensile Strength	450 ± 10 MPa	BS-1052
10.	Packing	Standard Packing as per latest instruction(s) by consignee	-

BINDING WIRE

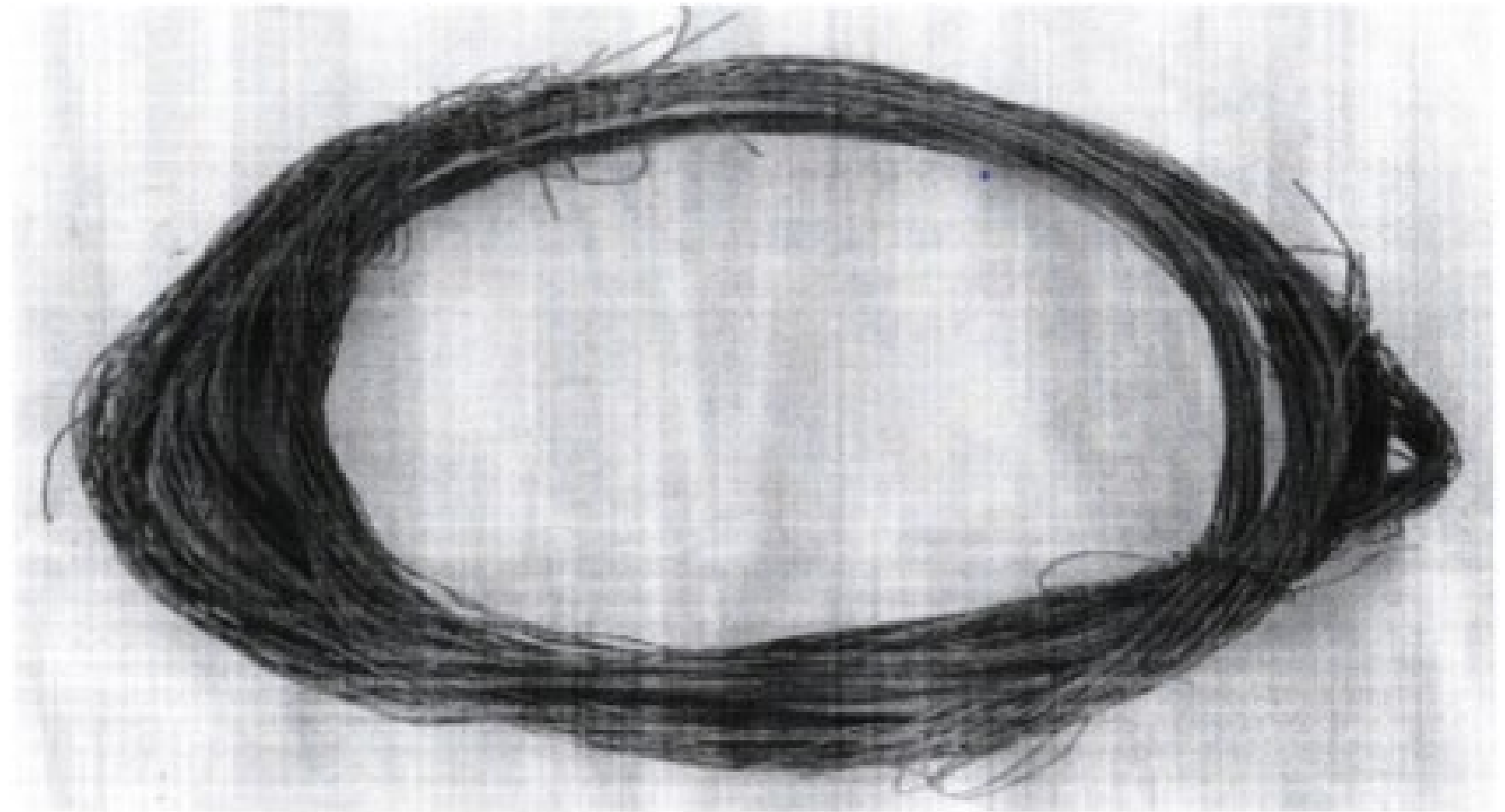

TECH DATA

ANCHOR BAR

(Tech data is property of Govt of Pakistan and liable to amendments any time. It must be returned to Chief Inspector, Inspectorate of Army Stores and Clothing Karachi on Demand or immediately on completion the purpose for which it was issued)

Ser	Parameters	Specified Limits	Std Method
1.	Use	Fencing equipment for Border security	-
2.	Make, Shape and Design	As per approved sample and drawing	-
3.	Colour	Silver	-
4.	Dia	7.8±0.2 mm	Vernier Caliper
5.	Length	11 inch (280 mm)	Measuring Scale
6.	Material	Mild Steel	ASTM E 415
7.	Galvanization	Hot Dip Galvanized No Copper deposition up to 4 th dip	BS 443:1982
8.	Zinc Coating	245 g/ m ² (min)	BS 443:1982
9.	Packing	Standard Packing as per latest instruction(s) by consignee	-

ANCHOR BAR

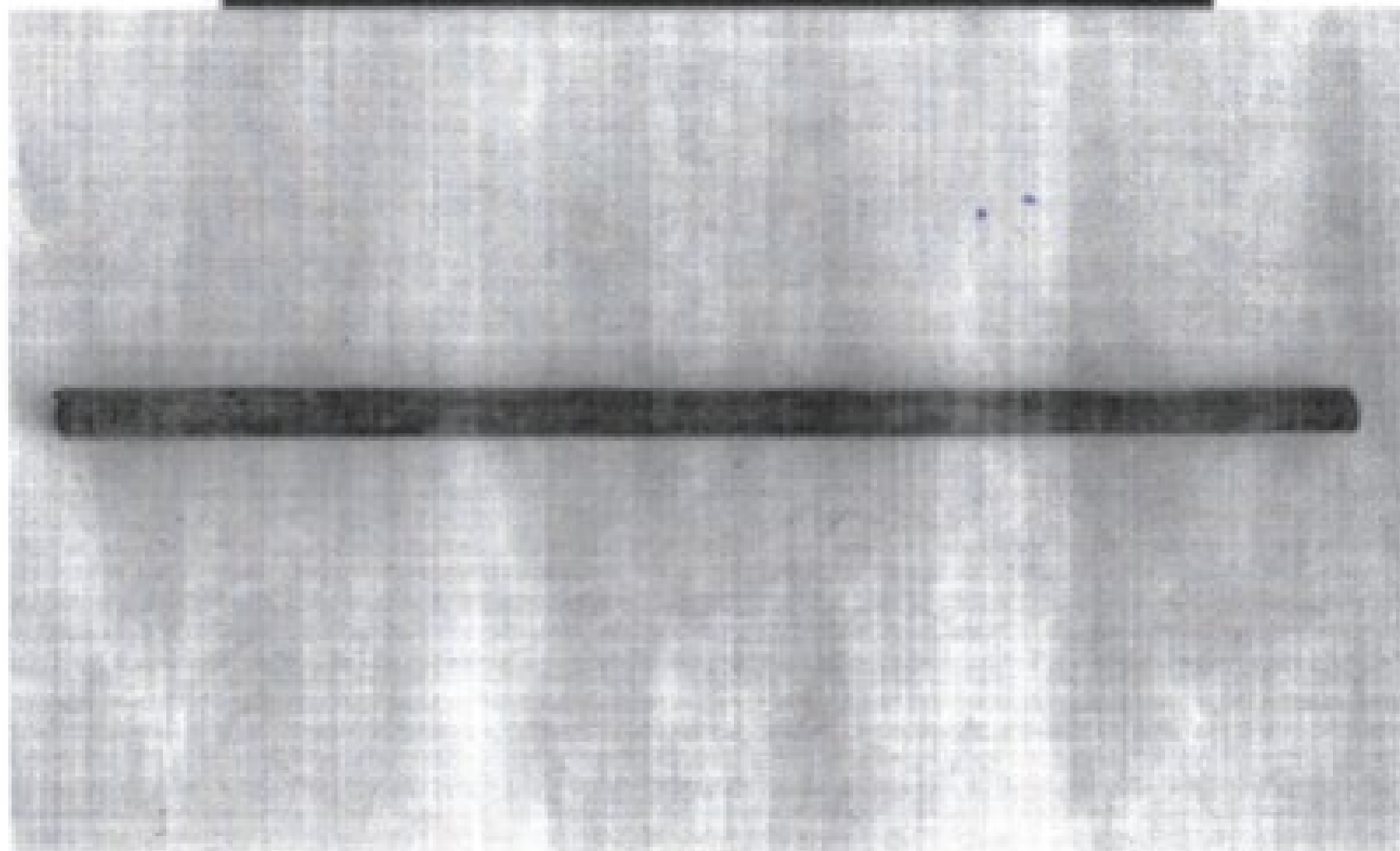

TECH DATA
JUBILEE CLAMP

(Tech data is property of Govt of Pakistan and liable to amendments any time. It must be returned to Chief Inspector, Inspectorate of Army Stores and Clothing Karachi on Demand or immediately on completion the purpose for which it was issued)

Ser	Parameters	Specified Limits	Std Method
1.	Use	Fencing equipment for Border security	-
2.	Make, Shape and Design	As per approved sample and drawing	-
3.	Colour	Silver	-
4.	Clamp Main Sleeve/ Strip		
	a. Gauge	16 SWG	SWG
	b. Length	290mm	
	c. Thickness	1.5mm (Min)	Micrometer
	d. Width	13mm	Measuring Scale
	e. Hardness	48±3 HRB	ASTM E-18
	f. Material	Mild Steel	ASTM E 415
	g. Carbon %	≤ 0.2%	
	h. Zinc Coating	70 g/m ² (Min)	BS 443:1982
	i. Galvanization	Hot Dip Galvanized No Copper deposition up to 2 nd dip	BS 443:1982
	Clamp Size Adjustment Nut & Bolt		
	a. Material	Mild Steel	ASTM E 415
	b. Carbon %	≤ 0.2%	
	c. Width	12.7mm	Micrometer
	d. Zinc Coating	70 g/m ² (Min)	BS 443:1982
	e. Galvanization	Hot Dip Galvanized No Copper deposition up to 2 nd dip	BS 443:1982

RESTD
DRAWING - JUBILEE CLAMP

DATE: 10/01/2011



TOP VIEW

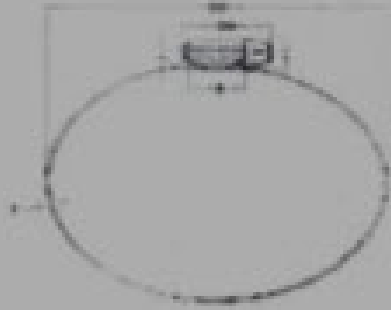

FRONT VIEW

SCALE: 1:1		
APPROVED:		
DATE:	AUTHOR:	

DRAFT DRG

DESIGNER:	DATE:
CHECKED:	SCALE:
APPROVED:	DRG No:

TITLE -

**FENCING MATERIAL
 JUBILEE CLAMP**

PROJECTION:	SCALE:	DRG No:
	1:1	
DATE: 10/01/2011		
AUTHOR: [Name]		

Copyright © 2011 by RESTD. All rights reserved. No part of this drawing may be reproduced without the written permission of RESTD.

NEW JUBILEE CLAMP

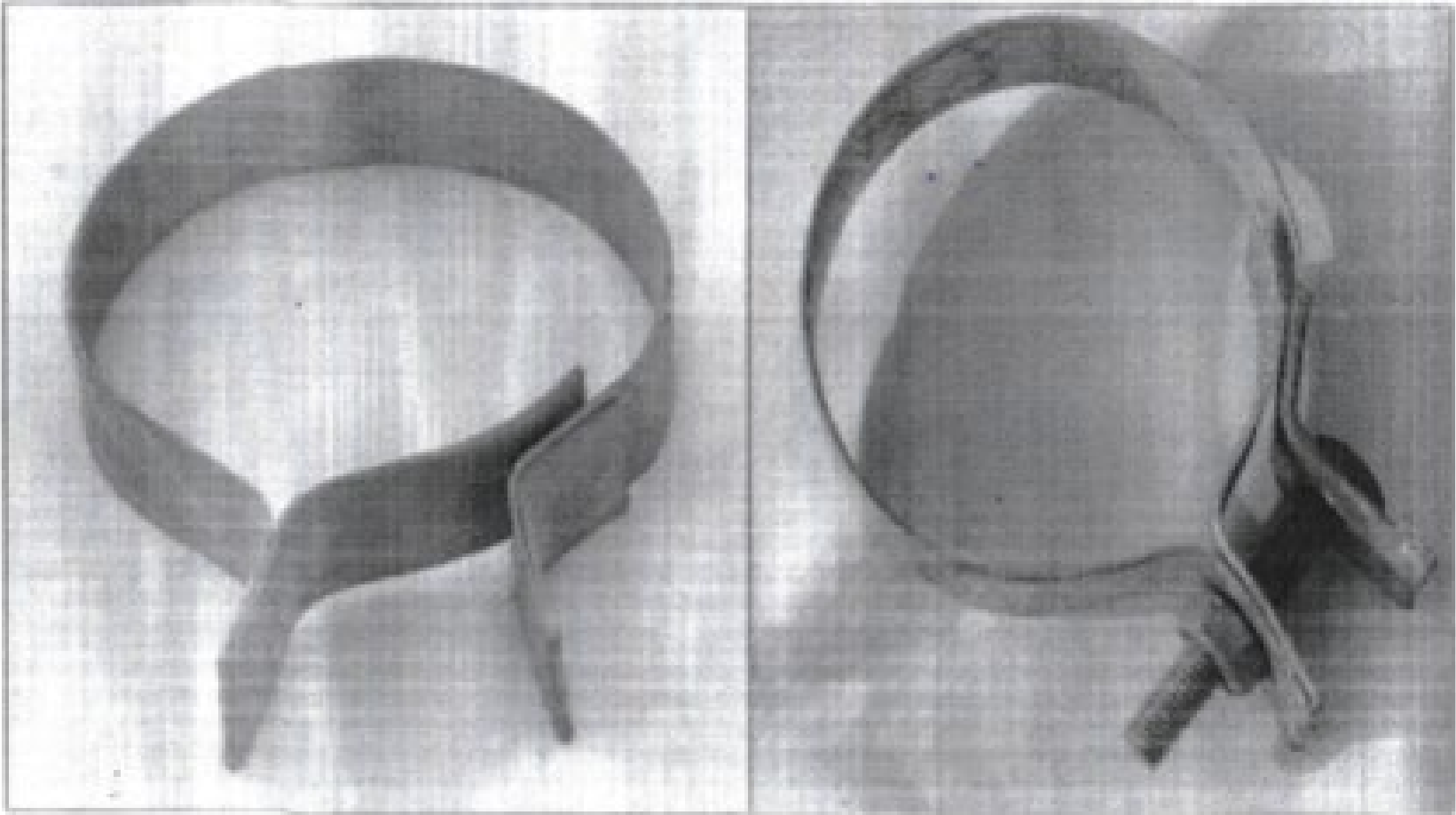

TECH DATA

MINE MARKER

(Tech data is property of Govt of Pakistan and liable to amendments any time. It must be returned to Chief Inspector, Inspectorate of Army Stores and Clothing Karachi on Demand or immediately on completion the purpose for which it was issued)

Ser	Parameters	Specified Limits	Std Method
1.	Use	Fencing Equipment for Border security	-
2.	Make, Shape and Design	As per approved sample and drawing	-
3.	Colour	Silver	-
4.	Metallic Strip		
	a. Gauge	16 SWG	SWG
	b. Thickness	1.5mm (Min)	Micrometer
	c. Width	25.4 mm (1 Inch)	Measuring Scale
	d. Hardness	48±3 HRB	ASTM E-18
	e. Material	Aluminium	
	Material Composition		
5.	a. Aluminium	98%	ASTM E 415
	b. Iron	0.2%	
6.	Rivrit Material	Aluminium	
7.	Packing	Standard Packing as per latest instr (s) by consignee	-

DRAWING - MINE MARKER

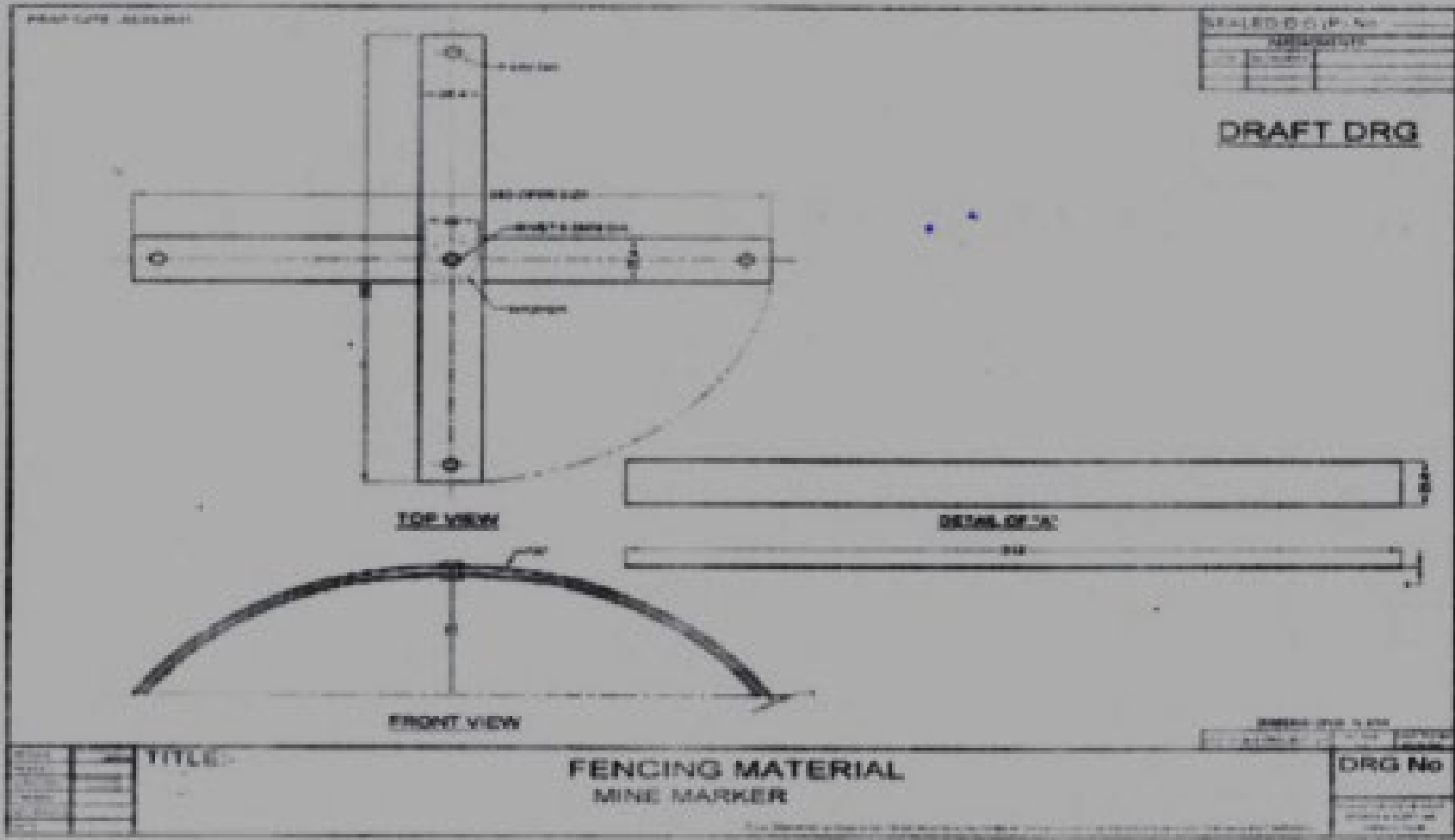

CENTRAL ORDNANCE DEPOT - KARACHI

Central Ordnance Depot
Karachi - 15
Tel : Mil 021-34570010
1002/KRD-03/24-25/ /LP
9 Dec 2024

To: The Assistant Director IT, PPRA
1st Floor, FBC Building, Near State Bank of Pakistan
Sector G 5/2 Islamabad
(Attention Mr. Rizwan Mehmood)

Subj: **INVITATION TO TENDER AND GENERAL INSTRUCTIONS FOR ORDNANCE STORE**

1. Date and time of closing of tender is **30 Dec 2024** up to **1030** hours.
2. Date and time of opening of tender is **30 Dec 2024** at **1100** hours.
3. Rates are invited for supply of stores as mentioned in the list attached at Anx 'A' to Anx 'C' to this tender inquiry.

- a. **Standard packing of items is attached as per appendix I to Annexure A to this tender respectively. Items included in tender other than listed are packed appropriately as per international packing.**

4. Store (s) purchased will be delivered in Depot / Unit (s) located in following places on as and when ordered basis.

- a. Karachi
- b. Malir Cantt
- c. Pano Aqil Cantt
- d. Hyderabad Cantt

5. **TERMS AND CONDITIONS GOVERNING BIDDING / PURCHASES AND GENERAL**

INSTRUCTION FOR BIDDERS:- Following are the terms / conditions and general instructions for bidders:-

- a. The purchaser can waive off any of the condition (s) stipulated in this Tender Inquiry and reserves the right to accept or reject thereto.
- b. Bidders should note that decision of Commandant Central Ordnance Depot Karachi will be final and binding in respect of acceptance / rejection of the offer (s).
- c. All supplies will be subject to tests and inspection (s) either by a Board of Officers constituted for the purpose or by ASID / IAS&C or user acceptance. Any cost incurred on tests / inspection (s) and store (s) consumed in the same will be borne by suppliers(s).

- d. Successful bidders will have to complete the supplies within stipulated period as specified in the purchase order(s), failing which appropriate penalty as decided by Commandant Central Ordnance Depot Karachi / Commanding Officer(s) of Ordnance Units(s) will be imposed alongwith, necessary / appropriate disciplinary action.
- e. **Store offered would be brand new, unused, as per Army's approved specifications, drawing, sample(s) where applicable and must be packed in standard packing i.e. wooden box, carton, cardboard box, crate etc.**
- f. During warranty period (if store(s) supplied is/are backed by warranty) if a fault (s) occurs in supplied store (s) then supplier will be responsible to either rectify the fault(s) communicated or get the faulty part(s) replaced within 7 (seven) days of receipt of information in this regard from the purchaser at his specified place(s) which can be other than the place of delivery of store (s). In case supplier fails to rectify the fault(s) or replace the faulty part(s) in a specified time then purchaser will have the right to take disciplinary action against the supplier and also impose penalty if considered necessary / appropriate.
- g. During warranty period, it will be the responsibility of the supplier to carry out periodic maintenance of supplied store (s) as prescribed by the manufacturers free of cost at purchaser's specified place (s) which can be other than the place of delivery of store(s)
- h. In case an item has no specifications, drawing or approved sample by Army then a Board of Officers appointed for the purpose will decide its acceptable standard(s)
- i. Make / Model / Brand and Country of Origin of store(s) must be mentioned where applicable.
- j. Price / Rate(s) will be quoted for store(s) as per Army's Specification(s), drawing (s) and approved sample(s) where applicable.
- k. Price(s) / Rate(s) will be quoted on delivery basis at COD Karachi.
- l. Price(s) / Rate(s) quoted must be inclusive of all applicable taxes / duties.
- m. Price(s) / Rate(s) quoted must be net per accounting unit.
- n. Price/Rate (s) will be quoted in Pakistani Currency.
- o. Price(s) / Rate(s) quoted will be valid for **30 Jun 2025** from date of opening of tender(s).
- p. Bid Security / performance guarantee may be asked, if required.
- q. Part delivery / Part payment will not be accepted / made.
- r. Payment will be made after acceptance of ordered store(s).
- s. Price reduction (PR) will also be imposed due to deviation in case the item (s) are not as per Army specs

- t. Successful bidder(s) will have to supply store(s) as per price(s) / rate(s) quoted for six months from date of opening of tender's or else appropriate disciplinary action will be taken against them.
- u. Sample(s) test/inspection for acceptance of store(s) to be supplied against purchase order(s) will not be taken as test / inspection processes will only commence when complete / ordered quantity(s) has been supplied.

6. **Special Instructions.**

- a. As far as possible price(s) / rate(s) must be quoted against each item, where price(s) / rate(s) are not being quoted this should be reflected by words "Not Quoted".
- b. List of store(s) (hard copy) will be submitted duly typed, (not hand written) signed and stamped on each paper or else offer will be rejected.
- c. **Price(s) / Rate(s) quoted must be typed and not hand written on hard copy or else offer will be rejected.**
- d. No change should be made in soft copy of tender inquiry provided (list of store(s) and bidders should fill price(s) / rate(s) in front of the item(s) without deleting / amending any column / row and without disturbing the serial number(s).

7. **Purchaser's Right.** Purchaser does not pledge to accept the lowest or any tender and reserves the right of accepting the whole or any part of the offer made.

8. **Delivery of Tender.** The offer is to be submitted while using **USB (soft copy in Excel Sheet)** (no change in tender ser) / List of stores(s) (hard copy) issue with tender inquiry documents in one envelope.

9. **Date and Time of Receipt of Tender.** Your tender must reach this office / dropped in tender box placed at reception of Local Purchase Branch by time and date as specified in para above. This office will not accept any excuse of delay occurring in post. Tenders received after the appointed / fixed time will not be entertained. The appointed time will fall on next working day in case of closed / forced holiday.

10. **Tender Opening.** Tender will be opened as per above mentioned time on same day.

11. **Validity of Offer(s).** The validity of offer(s) will be **30 Jun 2025**. The period of which will commence from the date of opening of the tender(s).

12. **With-drawl of Offer.** If a bidder / firm withdraw(s) its offer within validity period the competent authority (Commandant Central Ordnance Depot Karachi) may place such bidder / firm under embargo or blacklist the same.

13. **Disqualification.** Offer (s) are liable to be rejected if:-

- a. There is any deviation from General / Special Instructions/Pre-qualification of supplier/contractors.

- b. Price(s) / Rate(s) are offer excluding / applicable duties / taxes.
- c. If price(s) / rate(s) are not quoted (where applicable) against store(s) / item(s) with Army's approved specification(s), drawing(s) / sample(s).
- d. Offers are found conditional or incomplete in any respect.
- e. Multiple price(s) / rate(s) quoted against an item.
- f. More then one offer is made / submitted in same envelope.
- g. Received later than appointed / fixed date and time.
- h. Offers containing non – initialed un authenticated correction / over writing(s).
- i. Offers not submitted while using CD (soft copy) / List of store(s) (Hard Copy) issued with tender inquiry documents.
- j. If validity of offer is not quoted as required (as mentioned in tender inquiry) or made subject to confirmation later.
- k. Offer made through Fax / E–mail /Telex.
- l. If offer is found to be based on cartel action in connive with other sources / participants of the tender.

14. **Right's Reserved.** Commandant Central Ordnance Depot Karachi reserves the rights to accept or reject any or all offers including the lowest.

15. **Application of Official Secret Act.** All the matter connected with the inquiry and subsequent actions arising there from are within the scope of official secret Act, 1923.

Note: This tender inquiry is also available on PPRA website www.PPRA.org.pk

Maj
For Comdt
(Rukhsana Zenab)

TENDER ZCST 2nd HALF - FY 2024-25**Special Instruction:-**

a. Rate of items will be quoted along with standard packing i.e. wooden box, carton, cardboard box, crate etc.

b. Tech details / brochures of items must be attached with tender inquiry if any.

Ser	Part No	Nomenclature	A/U	Rate
1	HA-12140	Abrasive Cloth Powder Emery Flour GRM	Kg	
2	5350-ZO-250-7760	Abrasive Powder Emery Flour	Kg	
3	5350-ZO-250-7763	Abrasive stick emery	Nos	
4	6830-ZO-250-7896	Acetylene, Technical	CUM	
5	5120-240-8702	Adapter 3/4" (Force)	Nos	
6	NIV	Adjustable Plier Parrot Type (Force)	Nos	
7	GP-VEHTA-04484	Adjustable Spanner	Nos	
8	NIV	Adopter 19x12.7 MM (Force)	Nos	
9	30100186	Adopter Grease Gun	Nos	
10	5120-240-8702	Adopter Socket 1/2"-3/8" (Force)	Nos	
11	2-5120-00-144-5207	Adopter Socket Wrench (Force)	Nos	
12	30106393	Air Filling Nozzle	Nos	
13	BW122C-28-18	Air Gun Duster (Best Quality)	Nos	
14	CA10B-3901435	Air Inflation Hose (Trk 5 Ton Isuzu)	Nos	
15	478B-83-910SB	Air Line (Air inflation Pipe with Valve)	Nos	
16	30106381	Air Line (Air inflation Pipe)	Nos	
17	LV6/MT-1/PMTA-3220	Air Line 5 Ton with Nozzle	Nos	
18	30101793	Allen Key Size 24,14,12,10,8,6,5,4,3, mm	Nos	
19	NIV-TEMP-0364	Aluminum Foil Heavy Duty	Sqm	
20	8140-ZO-101-8276	Ammo Carrier No 6/P MK-1	Nos	
21	8140-ZO-101-8277	Ammo Carrier no 7 TP MK-1	Nos	
22	6930-ZO-250-0789	Argon Tech 200/240 Cubic Ft (5.663 CUM) Std Cyl	Cuft	
23	NIV	Arm Saw (Best Quality)	Nos	
24	8455-ZO-250-3555	Armlet MP	Nos	
25	NIV	Articulation 1/2 -920/25 (Best Quality)	Nos	
26	UN-251-1704-1182	Atta Kneading Machine Large	Nos	
27	GP-GENSTO-21066	Auto Fire Extinguisher DCP 6 Kg for Roof	Nos	
28	5110-293-2336	Axe Hand for Veh	Nos	
29	5110-ZO-250-1023	Axe Single Bit Felling Head 2.04 Kg (4-1/2 Lbs) with Handle	Nos	
30	5110-ZO-250-1024	Axes Felling	Nos	
31	5120-ZO-250-1194	Axes Pick (4-1/2 Lbs)	Nos	
32		Axes Single Bit Hand (Head 963gms)	Nos	
33	NIV	Axle Castle Nut Spanner (Best Quality)	Nos	
34	5140-473-6256	Bag Tool Canvas Empty	Nos	
35	6650-ZO-211-0261	Ballistic Goggle Revision Z87+CSA z94 3 Ballistic Impact Standard UVEX China	Nos	
36	CC/1801-1479	Ballistics / Escort Goggles (Safety Goggles)	Nos	

Ser	Part No	Nomenclature	A/U	Rate
37	W10/6660-526-6041	Balloon ML-51A	Nos	
38		Ballistic Shield	Nos	
39	1010-ZO-101-4342	Band Retaining Small for Barrel Assy	Nos	
40	1305-ZO-250-2042	Bandolier for QRF Team	Nos	
41	54-23-54	Bar Extension 1/2" & 3/4 Drive	Nos	
42	5660-ZO-152-3542	Barbed Wire No-14 SWG	Kg	
43	7310-ZO-250-8146	Barrel Pump Inflation Manual Assy	Nos	
44	478DU-95-223SB	Bearing (NTN) B1502	Nos	
45	4210-ZO-152-6003	Beater Forest Fire	Nos	
46	7210-ZO-250-0670	Bed Sheet Cotton 254 CMx173CM (100"x68")	Nos	
47	6530-74-251-0321	Bed Side Cabinet	Nos	
48	7105-ZO-250-4668	Bed Stead Folding Steel Tubing (Weight 11.500 Kg with Shaheen Tape Newar Nyon)	Nos	
49	8465-ZO-250-9643	Belt Waist Ribbed Pattern Black BCC No.220 with Black Plastic Buckle Small	Nos	
50	8465-ZO-251-0232-0234	Belt Waist Ribbed Pattern Olive Nearest to Pontoon 17-1022 TP with Black Buckle Size Small, Med, Large	Nos	
51	8465-ZO-251-0008-0010	Belt Waist Ribbed Pattern White with Shoulder Strap Size Small, Med, Large	Nos	
52	2340-ZO-150-1745	Bicycle Man 24" (Sartaj National)	Nos	
53	GP-Genstore-00311	Bicycle Man's Folding with Out Accys Complete	Nos	
54	7210-ZO-250-4677	Blanket Bed GS	Nos	
55	7210-ZO-250-4679	Blanket Bed Scarlet Hosp Red	Nos	
56	7210-ZO-250-0577	Blanket Children White	Nos	
57	UN-250-0019	Blanket for Offrs Ward (Hosp Use) (Best Quality)	Nos	
58	5140-ZO-250-8433	Box Pack Transport General Purpose (BOX PTGP)	Nos	
59	NIV	Box Spanner 17x19 (Force)	Nos	
60	NIV-TPN-AIN-U-16657	Brg Race Puller Set of 4 for Passenger Car	Nos	
61	7290-ZO-250-5646	Broom Push Sweeper (with kara and gulla) Weight without kara and gulla 680.4 Gm)	Nos	
62	8010-ZO-250-6086	Brush , Varnish Flat 10.2 CM wide 4 "(Captain / Universal)	Nos	
63	8010-ZO-250-6083	Brush , Varnish Flat 13 MM 1/2 " (Captain / Universal)	Nos	
64	8010-ZO-250-6084	Brush , Varnish Flat 2.5 CM wide 2 " (Captain / Universal)	Nos	
65	8010-ZO-250-6085	Brush , Varnish Flat 5.1 CM wide 3 " (Captain / Universal)	Nos	
66	8020-ZO-250-7393	Brush Artist Lining Fitches 25.4 MM	Nos	
67	1090-ZO-100-6675	Brush Cleaning Small Arms	Nos	
68	1005-ZO-100-6785	Brush Cleaning Small Arms Rifle 7.62 MM G3	Nos	
69	1005-ZO-100-6788	Brush Cleaning Small Arms Rifle 7.62 MM G3 for Oiling	Nos	
70	4210-ZO-152-6006	Bucket Metal Fire, Capacity 3 ½ Gal Painted (21/22 Gauge)	Nos	
71	7240-ZO-250-5246	Bucket Metal Mild Steel (Enameled)	Nos	
72	7240-ZO-250-6156	Bucket Plastic with Lid Capacity 30 Lits (Nobel Wear)	Nos	
73	8465-ZO-250-5157	Buckle Plastic 1-" for Steel Helmet Male / Female	Nos	
74	4320-ZO-105-8146	Burner Assy Oil Cooker 45 Men Set	Nos	
75	4710-00-792-9886	Cable Cutter	Nos	

Ser	Part No	Nomenclature	A/U	Rate
76	7320-ZO-150-8141	Cap Filling	Nos	
77	8405-ZO-250-3851	Cap Knitted Comforter Khaki (Shade Identification Pantone No CISC-1 Ermine 18-1022 TPX)	Nos	
78	5340-ZO-100-6018	Cap Protective Dust	Nos	
79	1005-ZO-100-6721	Cap Protective Dust and Moisture Seal (Plastic) for Muzzle MG1A3P	Nos	
80	B3/1005-ZO-102-8539	Cap Protective Dust for MP5A2	Nos	
81	C1/1005-ZO-101-6146	Cap Rubber	Nos	
82	6830-ZO-250-7898	Carbon Dioxide, Technical	Kg	
83	5340ZO3517843	Wheel Heavy Duty, Caster Wheel along with Base Plate for LY 80 (Loading Cap 20 Ton)	Nos	
84	EI-6515-766	Chair Carrying Stool	Nos	
85	EI-6515-761	Chair Close Stool for Hosp Use	Nos	
86	7105-ZO-250-0239	Chair Folding Field (Coleman)	Nos	
87	7105-ZO-250-4669	Chair Folding Steel Tubing (Army Pattern)	Nos	
88	J1/UN-251-1702-0747	Chair Folding Steel Tubing (Zuflah)	Nos	
89	6850-ZO-210-7864	Chalk French	Kg	
90	9190-ZO-250-7800	Char Coal Wooden	Kg	
91	8465-ZO-250-1066	Chaugal Water Carrying Universal	Nos	
92	5140-473-6256	Chest Tool Empty (Steel)	Nos	
93	NIV-SS-2152	Chest Cord Lead for Crew Helmet 889	Nos	
94	8465-ZO-250-9810	Chest Rig Complete	Nos	
95	6850-00-224-6663	Cleaning Compound Solvent	Lit	
96	1010-ZO-100-8019	Cleaning Rod for 37 mm Gun	Nos	
97	7330-ZO-250-5262	Cleaver, Meat 254.0 MM (10-IN LG Blade)	Nos	
98	5350-ZO-250-7809	Cloth Abrasive Emery Glass Grade '0'	Nos	
99	5350-ZO-250-7810	Cloth Abrasive Emery Glass Grade 1	Nos	
100	5350-ZO-250-7803	Cloth Abrasive Emery Grade -0	Nos	
101	5350-ZO-250-7802	Cloth Abrasive Emery Grade '00'	Quire	
102	5350-ZO-250-7805	Cloth Abrasive Emery Grade -1	Nos	
103	5350-ZO-250-7806	Cloth Abrasive Emery Grade -1-1/2	Nos	
104	5350-ZO-250-7807	Cloth Abrasive Emery Grade -2	Nos	
105	5350-ZO-250-7808	Cloth Abrasive Emery Grade 2-1/2	Nos	
106	5350-ZO-250-7804	Cloth Abrasive Emery Grade F	Quire	
107	5350-ZO-250-7801	Cloth Abrasive Grade-2	Nos	
108	7920-ZO-250-4688	Cloth cleaning	Nos	
109	7920-ZO-250-4687	Cloth Cleaning Dosuti	Nos	
110	8305-Zo-250-0826	Cloth Cotton Khaki	Mtr	
111	8305-Zo-250-0840	Cloth Cotton white	Mtr	
112	8305-ZO-250-0847	Cloth Dosuti Cotton Blue 91.4 CM (36-IN)	Mtr	
113	8305-ZO-250-0849	Cloth Dosuti Cotton Cedar Green 91.4 CM (36-IN)	Mtr	
114	8305-ZO-250-0853	Cloth Dosuti Cotton Scoured 91.4 CM (36-IN)	Mtr	
115	8305-ZO-250-0874	Cloth Hessian Jute No.1	Mtr	
116	KC-1406	Cloth Sponge	Nos	
117	CN/PCN/0011/W	Cloth Strip Khaki / Black	Mtr	
118	115-583-03-15	Combination Wrench 7-8-10-11-13-14-17-19-21 mm (Force)	Set	
119	1005-ZO-100-6642	Container Cleaning Kit Filled G-3	Nos	
120	UN-251-1708-1312	Cooking Set 10 Men Aluminum	Set	

Ser	Part No	Nomenclature	A/U	Rate
121	UN-251-1708-1310	Cooking Set 150 Men Aluminum	Set	
122	7360-ZO-250-5275	Cooking Set 150 Men Set Parat 610 MM (24")	Nos	
123	KF/UN-251-1708-1311	Cooking Set 45 Men Aluminum	Set	
124	7380-ZO-250-5290	Cooking Set 45 Men Karahi 305 MM (12" Dia)	Nos	
125	7360-ZO-250-5280	Cooking Set 45 Men No. 1 Complete	Nos	
126	7360-ZO-250-5291	Cooking Set 45 Men Parat 335 MM (13-3/16" Dia)	Nos	
127	7360-ZO-250-5293	Cooking Set 45 Men Pot Cooking 229 MM 9 in Dia	Nos	
128	PKF-0205	Cooking Set 45 Men Spoon MK-2	Nos	
129	7360-ZO-250-5295	Cooking Set 45 Mens Pot Cooking 279 MM (11")	Nos	
130	7360-ZO-250-5296	Cooking Set 45 Mens Pot Cooking 305 MM (12")	Nos	
131	7360-ZO-250-5297	Cooking Set 45 Mens Pot Cooking 330 MM (13")	Nos	
132	7360-ZO-250-5273	Cooking Set Large 150 Men Set	Nos	
133	6360-ZO-250-5274	Cooking Set Large Cover Cooking Pot 711 mm (28") Dia	Nos	
134	7360-ZO-250-5276	Cooking Set Large Parat 1143 MM (45") Dia	Nos	
135	7360-ZO-250-5277	Cooking Set Large Pot Cooking 648mm (25-1/2" dia)	Nos	
136	7360-ZO-250-5279	Cooking Set Large Tawa Circular	Nos	
137	6230-378-2053	Cord Light Extrusion Insp	Nos	
138	8030-ZO-250-5629	Corrosion Preventive Compound Soft Film Cold Application PX-1 (Un Dyed) NATO Code C-614	Lit	
139	8030-99-910-0484	Corrosion Preventive Oil Thin Film PX-4	Lit	
140	NIV	Cotton Dust Pouch	Pkt	
141	5338	Cotton Rags	Kg	
142	1010-ZO-100-7182	Cover Barrel for 57mm AA Gun	Nos	
143	6360-ZO-250-5283	Cover Cooking Pot 222 MM (8-3/4") Dia	Nos	
144	6360-ZO-250-5284	Cover Cooking Pot 248 MM (9-3/4") Dia	Nos	
145	7360-ZO-250-5285	Cover Cooking Pot 273 MM (10-3/4") Dia	Nos	
146	6360-ZO-250-5286	Cover Cooking Pot 298 MM (11-3/4") Dia	Nos	
147	6360-ZO-250-5287	Cover Cooking Pot 324 MM (12-3/4") Dia	Nos	
148	7360-ZO-250-5288	Cover Cooking Pot 349 MM (13-3/4") Dia	Nos	
149	1010-ZO-102-4667	Cover Dual Barrel (37mm AD Gun)	Nos	
150	8465-ZO-251-0167	Cover Entrenching Tool PLCE	Nos	
151	1010-ZO-100-8098	Cover Gun 37mm	Nos	
152	1010-ZO-101-4331	Cover Gun Muzzle RPG7	Nos	
153	M2/PMB/0003/W	Cover Gun Overall 35mm AD Gun	Nos	
154	1010-ZO-102-7202	Cover Gun Overall 37mm AD Gun	Nos	
155	1010-ZO-102-5558	Cover Gun Overall 57mm AD Gun	Nos	
156	NIV	Cover Mortar 120 MM	Nos	
157	NIV	Cover Mortar 60 MM	Nos	
158	NIV	Cover Mortar 81 MM	Nos	
159	1010-ZO-101-4333	Cover Rear End For RPG -7	Nos	
160	NIV	Crank Handle for Spare wheel Device	Nos	
161	NIV-SS-UN-6815	Crew Helmet Summer for Radio Set 889 (New)	Nos	
162	NIV-SS-UN-6815	Crew Helmet Summer for Radio Set 889 (RC)	Nos	
163	NIV-SS-UN-6816	Crew Helmet Winter for Radio Set 889 (RC)	Nos	
164	NIV-SS-UN-6816	Crew Helmet Winter for Radio Set 889 (New)	Nos	
165	8030-ZO-250-8050	Creosote Coalter Oil	Lit	
166	5120-ZO-150-4021	Crow Bar Chisel & Claw 4'x1"x1-1/4" Round	Nos	

Ser	Part No	Nomenclature	A/U	Rate
167	5120-ZO-150-4022	Crow Bar Chisel & Claw 5'-6"x1-1/2" Round	Nos	
168	5120-ZO-150-4025	Crow Bar Chisel &Diamond Point 5'-6"x1-1/2" Round	Nos	
169	5120-240-6040	Crow Bar Pinch Point 1" x48"	Nos	
170	KA/6530-ZO-251-0326	Crush Trolley for Hospital	Nos	
171	5110-ZO-150-4031	Cutter Cable 7-IN	Nos	
172	5120-ZO-150-4866	Cutting Nipper 160mm	Nos	
173	5120-ZO-150-4866	Cutting Nipper 160mm	Nos	
174	F6/8120-ZO-152-3674	Cyl Compressed Gas Oxygen 100 cuft 2840 ltr cap	Nos	
175	8120-ZO-152-6078	Cyl compressor gas oxygen empty 6-8 cum	Nos	
176	8120-ZO-152-3667	Cyl hydrogen tech 340 cuf	Nos	
177	8120-ZO-152-3345	Cylinder Nitrogen Empty 6.23CUM	Nos	
178	6830-00-840-6578	Cylinder Nitrogen Tech 340 Cu Ft	Nos	
179	6830-00-264-9086	Cylinder Nitrogen Technical 275 CU.Ft	Nos	
180	8120-ZO-152-3674	Cylinder oxygen 100 cft	Nos	
181	8120-ZO-152-3675	Cylinder oxygen 200 cft w/o cap	Nos	
182	919-915-40508	D/E Spanner Set (Qty 5) Size 30/32, 27/24, 22/19, 17/13, 10/8 (Force)	Set	
183	UN-250-0296	Desert Mats 12'x2'	Nos	
184	GP-GENSTO-18989	Desiccant Activated Silica Gel 28 Gm Bag	Bag	
185	GP-GENSTO-09986	Desiccant Activated Silica Gel 57 Gm Bag	Bag	
186	H1/6850-ZO-250-7329	Desiccant Activated Silica gel Indicating Type 227 Gm Bag	Bag	
187	H1/6850-ZO-250-7328	Desiccant Activated Silicagel Indicating Type 113 Gm Bag	Nos	
188	6850-ZO-250-7329	Desiccant Silica gel Indicating Type 227gm Bag	Nos	
189	6850-ZO-250-7330	Desiccant Silica gel Indicating Type 454gm Bag	Nos	
190	GP-VEHTA-06927	Diesel Filler	Nos	
191	5120-ZO-250-5554	Digging Tool	Nos	
192	919-915-40508	Double Ended Open Spanner (8x Pieces) Size 36/32, 32/30, 27/24, 22/19, 14/12, 11/10 10/8 & 13/17 (Force)	Set	
193	GP-VEHTA-07116	Double Ended Spanner Size 36/32,32/30,27/24, 22/19, 14/12 ,11/10,10/08&13/17	Nos	
194	09816-00035-1	Drain Plug	Nos	
195	KA/6530-74-251-0319	Dressing Treatment Trolley	Nos	
196	NIV-MT-000036	Driver Hand Book	Nos	
197	7210-ZO-250-1754	Durree Blue 183 CM x 91 CM (6 Ft x 3 Ft)	Nos	
198	H4/UN-250-0375	Easy Chair for Field	Nos	
199	8310-ZO-250-1122	Elastic Black 3"	Mtr	
200	UN-250-0283	Elbow Protection	Prs	
201	5130-ZO-153-2265	Elec Drill Large with Key	Nos	
202	GP-GENSTO-08108	Electrode welding bronze	Mtr	
203	GP-GENSTO-08110	Electrode Welding Cast Iron Non Machinable 4.0 Mm Dia	Mtr	
204	GP-GENSTO-08113	Electrode welding steel austenitic	Mtr	
205	GP-GENSTO-08115	Electrode welding steel austenitic 18% cr- 8% ni end grip 3.25 mm dia	Mtr	
206	3439-ZO-101-3338	Electrode Welding Steel End Grip 2.00 MM Dia	Mtr	
207	3439-ZO-101-3337	Electrode Welding Steel End Grip 2.50 MM Dia	Mtr	

Ser	Part No	Nomenclature	A/U	Rate
208	3439-ZO-101-3335	Electrode Welding Steel End Grip 3.25 MM Dia	Mtr	
209	GP-GENSTO-18978	Electrode welding steel end grip 3.25 mm Dia	Mtr	
210	3439-ZO-101-3334	Electrode Welding Steel End Grip 4.000 MM Dia	Mtr	
211	NIV	Emergency Reflecting Triangle with Plastic Box	Set	
212	GE-GENSTO-19648	Emery Sheet	Nos	
213	4210-ZO-152-6022	Engine Gasoline Fire Hose Linen Unlined 75 Ft	Nos	
214	4210-ZO-152-6021	Engine Gasoline Fire Pipe 2-3/4 In for 2-1/2 In W.W Coupling Hose Assy Linen Unlined 75 Ft	Nos	
215	4210-ZO-152-6013	Engine Gasoline Fire, Coupling, Instantaneous Female	Nos	
216	4210-ZO-152-6014	Engine Gasoline Fire, Coupling, Male	Nos	
217	4210-ZO-152-6024	Engine Gasoline Fire, Pipe Stand, Outlet Single Headed	Nos	
218	KA-6530-74-251-0322	Examination Coach for Hosp Use	Nos	
219	4210-ZO-153-2813	Ext Fire DCP 1 KG (Filled)	Nos	
220	4210-ZO-153-2834	Ext Fire DCP 10 KG (Filled)	Nos	
221	4210-ZO-153-2847	Ext Fire DCP 100 KG (Filled)	Nos	
222	4210-ZO-153-2822	Ext Fire DCP 2 KG (Filled)	Nos	
223	478B-83-910SB	Ext Tyre Valve	Nos	
224	NIV	Extension ½ -255 mm length 920/22	Nos	
225	54-23-54	Extension Pipe for Wheel nut	Nos	
226	NIV	Extension tube L=6 m, to be used with inflator	Nos	
227	4210-ZO-153-2837	Extinguisher Fire DCP 50 Kg	Nos	
228	4210-ZO-152-6027	Extinguisher Fire Foam 2 Gal	Nos	
229	4210-ZO-152-6031	Extinguisher Fire Foam 30 To 34 Gal	Nos	
230	4210-ZO-152-6034	Extinguisher Fire Soda Acid 2 Gal	Nos	
231	4210-ZO-152-6038	Extinguisher Fire Soda Acid 30 to 34 Gallon Charges	Nos	
232	4210-ZO-152-7631	Extinguisher Fire Soda Acid 30/34 GI Charges	Nos	
233	4210-ZO-152-6032	Extinguisher Fire, Foam 30 to 34 Gallon Charges	Nos	
234	4210-ZO-152-6029	Extinguisher Fire, Foam, 2 Gallon Charges	Nos	
235	4210-ZO-152-6035	Extinguisher Fire, Soda Acid, 2 Gallon Bracket Wall	Nos	
236	5120-ZO-153-2329	Filler Gauge for Vehs	Nos	
237	NIV	Fire Alarm System / Hooter Manual /Mech	Nos	
238	4210-ZO-153-2824	Fire Ext DCP 5 Kg (Filled)	Nos	
239	KG/PKG-3597	Fire Ext DCP 8 Kg	Nos	
240	KG/PKG/3597	Fire Ext DCP 8 Kg (Filled)	Nos	
241	4210-223-9915	Fire Extinguisher 1 Kg for Vehs	Nos	
242	PKG-3054	Fire Fighting Suit (Large Size)	Nos	
243	PKG-3055	Fire Fighting Suit (Med Size)	Nos	
244	KG/PKG-3803	Fire Hooter (Addressable Type)	Nos	
245	Y3-WB-3196	First Aid Box for Vehs	Nos	
246	UN-250-0307	First Aid Kit Box (Local)	Nos	
247	PBB-0001	Flannelette 4"	Mtr	
248		Flap Rust 1200-1400x20	Nos	
249		Flap Rust 600x16	Nos	
250		Flap Rust 700-750x16	Nos	
251	5110-00-211-1075	Flat type Chisel 150 mm	Nos	
252	NIV	Floor Matt for Vehs	Nos	
253	KG/4210-ZO-250-9005	Foam Making Compound (Germany)	Lit	

Ser	Part No	Nomenclature	A/U	Rate
254	KG/4210-ZO-250-9005	Foam Making Compound (Local) Black	Nos	
255	CN/PCN/0012/W	Foam Sheet 6'x3'x1/2" (for Steel Helmet)	Nos	
256	GP-Genstore-23547	Folder File with Unit Monogram	Nos	
257	7330-ZO-250-4985	Food Container Insulated 1 Gal Mk-2	Nos	
258	7330-ZO-250-6441	Food Pan Stainless Steel	Nos	
259	CG/GS-642	Frag Proof Jacket	Nos	
260	KF/PKF-5639	Fumigation Spray Machine (Model-TS35A, China)	Nos	
261	GP-GENSTO-18680	Gas R-134A USA Cyl	Nos	
262	5360-ZO-153-0471	Gauge for Vehs	Nos	
263	5120-00-935-9920	Gauge Track Tension and Sprocket Wear	Nos	
264	NIV	Gauge Tyre Air Pressure	Nos	
265	8415-268-7859	Gloves Leather	Prs	
266	CC/8465-ZO-250-4267	Gloves Leather MT	Prs	
267	CC/8415-ZO-250-4265	Gloves Leather Size 9	Prs	
268	UN-251-1703-0835	Gloves Protective for QRF Team	Prs	
269	CC/8465-ZO-250-3369	Google Protective Fd MK-8 (Ballistic Goggles)	Nos	
270	6532-ZO-250-6118	Gown Operating Surgical Calico Cotton No.2 Green (BCC no.202)	Nos	
271	9150-ZO-250-6004	Grease Aircraft General Purpose Wide Temperature XG-293 (NATO Code O-204)	Kg	
272	9150-ZO-250-3716	Grease Graphite Medium XG-264 (NATO G-412)	Kg	
273	4930-253-2478	Grease Gun Hand	Nos	
274	4930-274-5711	Grease Gun Hand Push Pt Operated, Design, Spring Primed, 702 Cap	Nos	
275	4930-253-2478	Grease Gun with Lever	Nos	
276	5935-ZO-210-8771	Grease Guns, Hand No.2	Nos	
277	H1/9150-99-224-1793	Grease Multi-Purpose Low Temp range XG-287 (NATO Code G-354)	Kg	
278	9150-ZO-250-6003	Grease XG-269	Kg	
279	9150-ZO-220-2418	Grease XG-279	Nos	
280	2510-01-105-0779	Grill Cover for Vehs	Nos	
281	8340-ZO-250-1103	Ground Sheet Khaki	Nos	
282	GP-SIGTA-01780	Ground Stake with Strip for Antenna RC 292	Nos	
283	CD/UN-250-0308	Gum Boot Long All Sizes	Prs	
284	5120-00-223-4971	Hacksaw with blade of 300 mm	Nos	
285	22-0054-1	Hammer 1 LBS	Nos	
286	5120-900-6095	Hammer 10 Lbs	Nos	
287	5120-00-051-8546	Hammer 2 Lbs	Nos	
288	001-041-500-001	Hammer Rubber	Nos	
289	NIV-MT-000090	Hand Pump with emergency kit	Nos	
290	NIV	Hand Spring Balancer 10 Kgs	Nos	
291	120-28-054-1	Handle Drive Extension 1/2" Drive	Nos	
292	NIV	Handle Frover	Nos	
293	09020-10284-P	Handle L Type 3/4" Drive	Nos	
294	5120-ZO-250-1111	Handle Mattock Pick 91.4 CM (36")	Nos	
295	5120-ZO-250-1115	Handle Shovel GS Mk-3 Wood	Nos	
296	5120-ZO-250-1116	Handle Shovel Wood 76.2 cm (30")	Nos	
297	5120-ZO-250-1117	Handle Single Bit Axe 89.0 CM (35")	Nos	
298	5120-ZO-250-1118	Handle Single, Bit Axe 40.6 CM (16")	Nos	

Ser	Part No	Nomenclature	A/U	Rate
299	8405-ZO-250-9911	Hat Jungle Cam Size 54CM (6-1/2")	Nos	
300	8405-ZO-250-9912	Hat Jungle Size 56CM	Nos	
301	8405-ZO-250-9913	Hat Jungle Size 58CM	Nos	
302	8405-ZO-250-9914	Hat Jungle Size 60CM	Nos	
303	8405-ZO-250-9915	Hat Jungle Size 62 CM	Nos	
304	8405-ZO-250-9916	Hat Jungle Size 64CM	Nos	
305	KG/PKG-3806	Heat Detector	Nos	
306	8415-ZO-250-6294	Helmet Motor Cycle	Nos	
307	CF/8415-ZO-250-7627	Helmet MP Personal Plastic White with Chain Guard	Nos	
308	8415-ZO-152-1399	Helmet Soldiers OD Model ML Liner with Strap Chin Leather	Nos	
309	4210-ZO-152-6040	Hook Pintee Fire 12 Ft	Nos	
310	NIV	Hose Air r/u 3/8 72"	Nos	
311	NIV	Hose Electric Cable with Plug	Nos	
312	NIV	Hose Pipe 75 Fts Dia 3 Inch	Nos	
313	NIV	Hose Pipe Fire Ext 05 Kgs	Nos	
314	NIV	Hose Pipe Fire Ext 08 Kgs	Nos	
315	NIV	Hose Pipe Fire Ext 50 Kgs	Nos	
316	478B-83-910SB	Hose Pipe with Valve	Nos	
317	2540-832-7852	Hose Tyre Charge flexible	Nos	
318	EI-7320-778	Hot Ban Marry 3 x Trays 4 x Lit Min Cap for 50 Men (Food Graded Sheet Stainless Steel)	Nos	
319	KF/GS&C-251-0445	Hot Ban Marry 5 x Trays 4 x Lit Min Cap for 100 Men (Food Graded Sheet Stainless Steel)	Nos	
320	KF/GS&C-251-0447	Hot Ban Marry 5 x Trays 8 x Lit Min Cap for 150 Men (Food Graded Sheet Stainless Steel)	Nos	
321	9150-ZO-250-2697	Hydraulic Fluid Petroleum Base for Preservation & Operation PX-26 (NATO Code C-635)	Lit	
322	F6/6830-ZO-250-7901	Hydrogen Gas Technical	Cum	
323	LV6/MT-8/0957	Ignition Key	Nos	
324	453-7845-801	Inspection Lamp	Nos	
325	H1/8010-ZO-250-0218	Insulating Varnish Electrical	Lit	
326	NIV-SS-6705	INSULATION TAPE 3/4"	Roll	
327	5970-99-040-4464	Insulation Tape 1/2"	Nos	
328	CN/PCN/0004/W	Iron Clip for Steel Helmet USA Patt	Nos	
329	KA/6530-74-251-0324	IV Stand for Hospital	Nos	
330	30102723	Jerrican Spout	Nos	
331	7240-99-102-2405	Jerrican 4 Gls Fuel / Water	Nos	
332	30106384	Jerrican 4 Gls Water	Nos	
333		Jersey Men Pullover	Nos	
334	J2/PJB-1273	Jet Vaporizer	Nos	
335	NIV-MT-000132	Joint assy Universal 1/2"	Nos	
336	NIV-MT-000132	Joint Universal 1/2"	Nos	
337	8415-ZO-150-4658 to 4660	Jubba Religious Teacher	Nos	
338	Z1-5820-ZO-213-1177	Junction Box JB-80 S/P for VRC-80,81,81A	Nos	
339	5210-ZO-250-7473	Kahi Complete Blade Length 30 CM	Nos	
340	5120-ZO-250-7572	Kahi Halves Length 90 CM Dia 5 CM	Nos	
341	NIV	Karahi 18 inch	Nos	

Ser	Part No	Nomenclature	A/U	Rate
342	NIV-GS-691417	K-II-Oil	Lit	
343	1005-ZO-100-6641	Kit Container Cleaning G-3	Nos	
344	NIV	Kit ring 15/17	Nos	
345	NIV	Kit Uniform	Nos	
346	UN-250-0283	Knee protection	Prs	
347	8405-ZO-250-3838,3830	Kullah Khaki	Nos	
348	6532-ZO-250-6212-6214	Kurta Men's Cloth Poplin Sky Blue Mercerised-914.4mm (38-In) Small, Med, Large	Nos	
349	8335-ZO-250-0669	Laces Foot Wear Ctn Black for Boots 40"	Nos	
350	NIV	Ladder Aluminum Adjustable for Vehs	Nos	
351	KG/4210-ZO-152-2359	Ladder Extension Aluminum 28"	Nos	
352		Lantern Kerosene Complete	Nos	
353		Lantern Kerosene Globe Clear	Nos	
354		Lead seal with plastic wire	Nos	
355	CN/PCN/0005/W	Liner Ground Complete for Steel Helmet USA Pattern	Nos	
356	4925-ZO-101-6978	Linker DE linker Hand 7.62 M1A3P	Nos	
357	8010-ZO-250-0207	Linseed Oil Raw	Lit	
358	NIV-0370	LN Key 10,12,13,17 MM	SET	
359	NIV	LN Key Set (8 mm to 16 mm)	SET	
360	NIV-0370	LN Key Size 24, 14, 12, 10, 8, 6, 5, 4 & 3mm (9x Pieces)	SET	
361	7360-ZO-250-5292	Lota Aluminum Medium	Nos	
362	9150-12-125-9197	Lubricating Oil Aircraft Turbine Engine Petroleum Oil OM-11	Lit	
363	9150-12-125-3506	Lubricating Oil Mineral OM-13 (25 Lit Drum)	Lit	
364	H1/9150-ZO-231-2356	Lubricating Oil preservative Med	Lit	
365	H1/ PHA-7003	Lubricating Oil Semi Fluid (NATO Code No. 204) for 35 MM AA Gun (Oerlikon) GDF-005	Kg	
366	9150-ZO-250-8072	Lubricating Oil, Pet Compressor Light OM-58	Lit	
367	8465-ZO-250-0866	Magic Tape 1" Black / Olive Green	Mtr	
368	8465-ZO-250-0877	Magic Tape 3" Black / Olive Green	Mtr	
369	8465-ZO-250-9854	Magic Tape 4" Black / Olive Green	Mtr	
370	NIV	Magnetic Base Dial Items 2 Only	Set	
371	NIV	Map Reading Light	Nos	
372	5120-ZO-250-6194	Mattress Bed Polyurethane Foam	Nos	
373	7210-ZO-250-0711	Mattress, Bed Polythene Foam (Master 6'x3'x 4 1/2")	Nos	
374	KC/3990/NINGBO_TX-001	Matts Desert Recovery Material Nylon Capacity 10 Ton Size (1060x310 x 60mm) NINGBO HAISHU, China	Nos	
375	KC/3990/NINGBO_TX-002	Matts Desert Recovery Material Nylon Capacity 10 Ton Size (L-90"xW-13.5") NINGBO HAISHU, China	Nos	
376	EI-7320-776	Meat Box 20 Kgs for 50 Pers	Nos	
377	KF/GS&C-251-0444	Meat Box 40 Kgs for 100 Pers	Nos	
378	KF/GS&C-251-0443	Meat Box 60 Kgs for 150 Pers	Nos	
379	KF/7320-ZO-251-0288	Meat Mincing Machine	Nos	
380	UN-251-1704-1183	Meat Mincing Machine Large (Heavy Duty)	Nos	
381	NIV-ENGR-0021	Met Balloon 500 GM White	Nos	
382	6660-663-8159	Met Balloon ML-64A (30 Gm Red)	Nos	

Ser	Part No	Nomenclature	A/U	Rate
383	8415-ZO-150-1611-1	Mitten	Nos	
384	NIV	Mr Funnel	Nos	
385	9150-ZO-250-8074	Mustard Oil	Lit	
386	1015-00-550-6750	Muzzle Cover 37 MM gun	Nos	
387	5315-ZO-152-4556	Nail Common Wire Mild Steel Round shank 1-1/2 x 14 SWG	Kg	
388	5315-ZO-152-4560	Nail Common Wire Mild Steel Round shank 3" x 8 S.W.G	Kg	
389	G1/5315-ZO-152-4565	Nail Common Wire Steel Round Shank 6-IN Wire 4 SWG	Kg	
390	G1/5315-ZO-152-4566	Nail Common Wire Steel Round Shank 8-IN x 1 SWG 3/8 SWG	Kg	
391	6810-ZO-250-7842	Naphthalene Technical	Kg	
392	H5/1080-ZO-250-9917	Net Cam Polyester 14'x14' Complete with Accessories	Nos	
393	H5/1080-ZO-250-9919	Net Cam Polyester 26'x26' Complete with Accessories	Nos	
394	7210-ZO-250-6593	Net Mosquito 6 End Mockleno / Round Mesh Khaki (198CMx92CMx132) 78"x36"x51-3/4"	Nos	
395	UN-251-1705-1203	Net Mosquito Folding	Nos	
396	7310-ZO-150-8137	Nipple for Tank Pressure	Nos	
397	3830-ZO-250-7902	Nitrogen Gas Type 1 Class-1, Oil Free Grade-A	CUM	
398	F6/3820-ZO-250-7903	Nitrogen Gas Type-1 gde-B	CUM	
399	RECS-95252	Nose Plier	Nos	
400	4530-ZO-150-7080	Nozzle Fuel Oil Pressure	Nos	
401	J2/PJB-0011	Nozzle Fuel Oil Pressure (Burner Assy)	Nos	
402	7310-ZO-150-8733	Nozzle Jetting and Nozzle Fuel Oil Pressure (Burner Assy)	Nos	
403		Oil Cooker 45 Men Set Complete	Nos	
404	9150-ZO-250-8070	Oil OM-33	Lit	
405	4930-00-262-8868	Oiler Can Hand Type	Nos	
406	18573837	Open End Spanner 10 x 11 (Force)	Nos	
407	NIV-MT-000132	Open End Spanner 13 X 16 mm (Force)	Nos	
408	434-90-0059B-1	Open End Spanner 13 x14 (Force)	Nos	
409	NIV-MT-000132	Open End Spanner 19x17 (Force)	Nos	
410	NIV-0368	Open End Spanner 22 x24 (Force)	Nos	
411	434-90-0059B-1	Open End Spanner 24 X 27 mm (Force)	Nos	
412	41CLS38	Open Spanner 8x10,12x14,17x19,11x13,14x17, 22x24,41x36,24x30 (Force)	Nos	
413	NIV-0368	Open Spanner for M36 Nut (Force)	Nos	
414	4210-ZO-153-2953	O-Ring for DCP Cylinder 5 Kg	Nos	
415	4210-ZO-153-2954	O-Ring for DCP Cylinder 50 Kg	Nos	
416	H4/UN-250-0403	Over Bed Table for Patient Bed	Nos	
417	6830-ZO-250-7904	Oxygen Technical Refrigerant Gas	CUM	
418		Pad Lock 4"	Nos	
419	G1/5340-ZO-152-4641	Pad Lock Iron Galvanized 4 Lever Type 1-1/4"	Nos	
420	5340-00-682-1645	Pad Lock with Key	Nos	
421	8405-ZO-250-6641	Pagri Malmal White	Nos	
422	NIV	Paint brush 3 inch	Nos	
423	GP-GENSTO-21273	Paint Remover	Lit	
424		Pauline 10'x10'	Nos	

Ser	Part No	Nomenclature	A/U	Rate
425	8340-ZO-250-1140	Pauline 168 x 117 Cm 5 ft 6-in x 3 ft10-in	Nos	
426		Pauline 20'x15'	Nos	
427	8340-ZO-250-1138	Pauline 244 x 183 Cm 8 x 6 ft	Nos	
428	8340-ZO-250-1141	Pauline 305 x 187 Cm 10 x 6 ft	Nos	
429	8340-ZO-250-1146	Pauline 732 x 549 Cm 24 x18 ft	Nos	
430	8340-ZO-250-1149	Pauline 854 x 854 Cm 30 x 30 ft	Nos	
431	8030-99-910-0485	Petrolatum Technical PX-6	Lit	
432	5120-ZO-250-1194	Pick Head Digging 2.4 Kg (4-1/2 Lbs)	Nos	
433	5120-ZO-250-1195	Pick Head Digging 2.95 Kg (6-1/2-Lbs)	Nos	
434	5120-ZO-152-3570	Pick Head Digging Mining No.1 MK-1	Nos	
435	7210-ZO-250-3713	Pillow Bed Cover White	Nos	
436	7210-ZO-250-3712	Pillow Bed Foam (Master Molty Foam)	Nos	
437	5315-00862-2683	Pin straight Tow Hook	Nos	
438	7310-ZO-150-8130	Pipe Bent Steel	Nos	
439	NIV	Pipe for Fire Ext DCP 05 Kg	Nos	
440	NIV	Pipe for Fire Ext DCP 08 Kg	Nos	
441	NIV	Pipe for Fire Ext DCP 50 Kg	Nos	
442	NIV-0401	Pipe Wrench 12" (Force)	Nos	
443	1095-ZO-250-2142	Pistol Holster	Nos	
444	NIV	Plastic Water Bottle with Cover	Nos	
445	005-231-240-200	Plier Adj (Parrot Type) 10" (Force)	Nos	
446	5120-223-7395	Plier Side Cutter 7"	Nos	
447	30105592	Plier Side Cutting 6"	Nos	
448	5120-ZO-150-4978	Plier Side Cutting 8"	Nos	
449	5120-ZO-150-4980	Plier Side Cutting Pipe Grip, Single Joint 8 Inch	Nos	
450	5120-00-293-7397	Plier Slip Joint 8"	Nos	
451	5510-ZO-210-3852	Pole Line Constr Wood 5.1816 Mtr	Nos	
452	5510-ZO-210-3853	Pole Line Wood 6.4008 Mtr	Nos	
453		Pot Cooking 11"	Nos	
454	7360-ZO-250-5294	Pot Cooking 254 MM (10") Dia	Nos	
455	7360-ZO-250-5292	Pot Cooking 8" Dia	Nos	
456		Pot Cooking 9"	Nos	
457	6810-98-220-0692	Potassium Dichromate (Potassium Bichromate) 500 Grm Btl	Btl	
458	7320-zo-251-0289	Potato Peeling Machine	Nos	
459	6850-ZO-250-7864	Powder Rubber Dusting	Kg	
460	GP-GENSTORE-10041	Powder Water Clarifying	Pkt	
461	MT1/PMTA-1707	Pressure Gauge	Nos	
462	NIV	Protection helmets	Set	
463	1090-ZO-100-6171	Pull Through Cord Single	Nos	
464	1090-ZO-100-6175	Pull Through Single MK-4B	Nos	
465	B2/1090-ZO-100-6176	Pull through Weight	Nos	
466	NIV	Pulley block to be opened, 05-ton capacity with rotating hook	Nos	
467	7310-ZO-150-8145	Pump Inflation Manual Assy	Nos	
468	NIV	Pump Lever	Nos	
469	WA-10050	Pumping Set No-5 (Jesco Diesel Water Pump)	Nos	
470	5120-01-06-8847	Punch Drift	Nos	

Ser	Part No	Nomenclature	A/U	Rate
471	6532-ZO-250-6215-6217	Pyjama Men's Cloth Poplin Sky Blue Mercerized (36") 914.4 MM Size Small, Med, Large	Prs	
472	NIV	Quick Strg Puller Asy Pin 102	Nos	
473	CH/8415-ZO-250-6306-6308	Rain Coat Impranil Coated Nylon Fabric Howard Green Bcc No.230 Small, Med, Large	Nos	
474	5120-ZO-153-2400	Ratchet Handle	Set	
475	9150-ZO-250-4955	Recoil Mechanism Fluid	Lit	
476	H1©/PHA-2467	Recoil Oil RL-4 (White Fluid)	Lit	
477	P30000929	Refrigerant Gas R-134A	Kg	
478	1010-ZO-100-4368	Retainer Firing Pin firing Brl Assy	Nos	
479	RE24023	Revolving Light for MP Jeep	Nos	
480	RE24023	MP Light Complete with Siren, Mic (Best Quality)	Nos	
481	353-7662-801	Ring Spanner 13x17	Nos	
482	NIV-MT-000132	Ring Spanner 16x17&18x19	Set	
483	KG.PKG-1327	Ring Washer for Gauge Cyl DCP 100 Kg	Nos	
484	1005-ZO-100-6676	Rod Cleaning Chamber Small Arms	Nos	
485	1010-ZO-101-4326	Rod Clg 40 MM RPG7	Nos	
486	3439-ZO-101-3487	Rod welding ACM 5% 3.2mm x1000mm	Mtr	
487	3439-ZO-101-3497	Rod Welding Brass 3.2 MM Dia x 1000 MM Long	Mtr	
488	3439-ZO-101-3498	Rod Welding Brass 5 MM Dia x 1000 MM Long	Mtr	
489	3439-ZO-101-3499	Rod Welding Brass 6 MM Dia x 1000 MM Long	Mtr	
490	3439-ZO-101-3506	Rod Welding Steel 3.2 MM Dia x 1000 MM Long	Mtr	
491	3439-ZO-101-3510	Rod Welding Steel 5 MM Dia x 1000 MM Long	Mtr	
492	3439-ZO-101-3514	Rod Welding Steel Alloy 6 MM Dia x 1000 MM Long	Mtr	
493	GP-GENSTO-08140	Rods welding bronze nickel 5 mm dia x1000 mm lg	Mtr	
494	GP-GENSTO-08139	Rods welding bronze nickel 5 mm dia x1000 mm long	Mtr	
495	3439-ZO-101-3505	Rods Welding Nickel Steel 1.6 MM Dia x 1000 MM Long	Mtr	
496	4020-99-942-5034	Rope Manila Gde 2,3 Strand 102 MM (4")	Nos	
497	2540-767-3149	Rope Towing Steel	Nos	
498	CN/PCN/0034/W	Rubber Chanel 1 Mtr for Lt Wt Helmet	Mtr	
499	NIV	Rubber hammer head & ball	Nos	
500	NIV	Safety Goggles	Nos	
501	CN/PCN/2322	Safety Helmet with Torch	Nos	
502	KG/PKG-1325	Safety Pin for DCP Cyl 5 Kg	Nos	
503	NIV	Safety Shoes	Nos	
504	5105-ZO-250-7691	Sand Bag Poly Propylene Khaki 85 cm x 35 cm with Twin Jute as Tying Cord	Nos	
505	5350-ZO-251-0508	Sand Blasting	Nos	
506	5110-ZO-152-2743	Saw hand 26" cross cutting	Nos	
507	5110-ZO-150-2742	Saw Hand Cross Cutting 18"	Nos	
508	8405-ZO-250-6171	Scarf Cotton Union Jack Red	Nos	
509	CC/8405-ZO-250-6171	Scarf Neck Wear Cotton Jack Red	Nos	
510	GP-ENRTA-03189	Scraper	Nos	
511	30102859	Screw Driver	Nos	
512	30104744	Screw Driver D/E with Grip	Nos	
513	30106376	Screw Driver Flat 8"	Nos	
514	GP-VEHTA-03541	Screw Driver Philips 8"	Nos	
515	5305-ZO-250-6941	Screw Heel Tip Lt Wt Helmet	Nos	

Ser	Part No	Nomenclature	A/U	Rate
516	5180-00-62-7052	Screw Thickness Gauge	Nos	
517	5340-ZO-152-5386	Seal Metallic Lead 3/8"	Nos	
518	5340-ZO-152-5388	Seal Metallic lead wire 18"	Nos	
519	5340-ZO-152-5387	Seal Metallic lead wire 5/8"	Nos	
520	7310-ZO-150-8736	Seat Valve for Oil Cooker	Nos	
521	5120-422-8972	Set Screw Wrench 3-4-5-6 mm (<i>L Type</i>)	Set	
522	8405-ZO-250-6637	Shalwar Latha white	Prs	
523	8405-ZO-250-6638	Sherwani Trouser (Cream / White)	Nos	
524	8405-ZO-250-6639	Sherwani Vicona Black	Nos	
525	8405-ZO-250-6636	Shirt Poplin, White	Nos	
526	8430-ZO-250-6642	Shoes Moccasin (Black)	Nos	
527	5120-293-3336	Shovel G.S	Nos	
528	5120-237-8611	Shovel Hand (China)	Nos	
529	5120-ZO-250-1241	Shovel Hand G.S (1.6 Kg (3-1/2 Lbs) with Straight Handle Shovel Wood	Nos	
530	5120-ZO-250-1243	Shovel Hand G.S Mk III	Nos	
531	-	Shovel RD Point	Nos	
532	GP-VEHTA-05799	Singled Gun Flexible Hose	Nos	
533	30105528	Singled Spanner 13 mm	Nos	
534	30108396	Singled Spanner 17 mm	Nos	
535	GP-VEHTA-06999	Singled Spanner 22 mm	Nos	
536	GP-VEHTA-05653	Singled Spanner 24 mm	Nos	
537	30105875	Singled Spanner 32 mm	Nos	
538	NIV	Site Adj Key for 37 mm gun	Nos	
539	8430-ZO-250-9285	Sleeper Men Hospital (All Sizes)	Prs	
540	8465-ZO-250-9902	Sleeping Bag Large	Nos	
541	1005-ZO-100-0630	Sling 7.62 MM SMG	Nos	
542	1010-ZO-101-4330	Sling for Recoilless Gun 40MM RPG7	Nos	
543	1005-ZO-102-8111	Sling SA MP5A2	Nos	
544	1005-ZO-100-6720	Sling Small Arms MG1A3 Complete	Nos	
545	1005-00-960-6520	Sling SMG 9x19 MM MP5A2	Nos	
546	8465-ZO-250-9980	Sling Web Rifle G-3	Nos	
547	1005-99-910-6519	Sling Web Rifle G-3 (Double)	Nos	
548	NIV-MT-000150	Small Wheel Brace	Nos	
549	NIV-SS-UN-2061	Smoke Detector	Nos	
550	NIV	Snape Wiring Plier Set 4 with Canvas Bag	Nos	
551	7930-ZO-250-6571	Soap Laundry 170 Gram Cake (6-OZ)	Cake	
552	7930-74-251-1589	Soap Laundry 250 Gram (Sufi Soap)	Cake	
553	7930-ZO-250-7879	Soap Laundry Yellow	Kg	
554	8520-ZO-250-8090	Soap Toilet 130gm (Palmolive)	Cake	
555	GP-VEHTA-08538	Socket Extension	Nos	
556	-	Socket 1/2 Drive (12 PT) 1" Open	Nos	
557	-	Socket 1/2 Drive (12 PT) 11/16" Opening	Nos	
558	-	Socket 1/2 Drive (12 PT) 1-1/16" Opening	Nos	
559	-	Socket 1/2 Drive (12 PT) 1-1/4" Opening	Nos	
560	-	Socket 1/2 Drive (12 PT) 13/16" Opening	Nos	
561	-	Socket 1/2 Drive (12 PT) 3/4" Opening	Nos	
562	-	Socket 1/2 Drive (12 PT) 5/8" Opening	Nos	

Ser	Part No	Nomenclature	A/U	Rate
563	-	Socket 1/2 Drive (12 PT) 7/16" Opening	Nos	
564	-	Socket 1/2 Drive (12 PT) 7/8" Opening	Nos	
565	-	Socket 1/2 Drive (12 PT) 9/16" Opening	Nos	
566	5120-189-7913	Socket 1/2" (24,22,19,17,14,13,10mm)	Set	
567	5120-189-7914	Socket 10,11,12,13,14,15,16,17,19,22,24 mm	Set	
568	30106381	Socket 3/4 Driver Size 30 mm	Nos	
569	5120-422-8972	Socket 3/4" Drive (36, 32, 30, 27mm)	Set	
570	41CLS38	Socket Box Iron (10,11,12,13,14,15,16,17,18, 19,20,21,22,23,24,27,	Set	
571	5120-189-7915	Socket Box Wrench ½ (13x16)	Nos	
572	5120-189-7913	Socket Box Wrench 10-11-12-13-14-17-19-22-24 mm	Set	
573	5120-189-7914	Socket Box Wrench 7/16,1/2,9/16,11/16,7/8	Set	
574	41CLS38	Socket Set (Qty 10) Size 32,30,27,24,22,19,17,14,13 &10	Set	
575	41CLS38	Socket Size (11x Pcs) 36, 32, 30, 27, 24, 22, 19, 17, 14, 13 & 10mm	set	
576	5120-ZO-153-2508	Socket With T-Handle (16,17,18,19,20,22)	Set	
577	5120-00-237-0984	Socket Wrench 1/2"	Nos	
578	5120-236-7590	Socket Wrench T-20	Nos	
579	NIV	Socks Nylon	Nos	
580	7920-ZO-250-4040	Soda Ash Commercial	Kg	
581	6810-ZO-250-7885	Sodium Carbonate Anhydrous Tech (ICI)	Kg	
582		Sodium Hydroxide Tech 500 Gm	Btl	
583	6810-ZO-250-7886	Sodium Hydroxide Technical	Kg	
584	H7/6810-99-220-0107	Sodium Nitrate	Kg	
585	6810-99-220-0090	Sodium Nitrite A.R (500 Gram alongwith Bottle packing)	Nos	
586	6810-ZO-250-4940	Sodium Phosphate, Tribasic 500 GRM Bottle	Btl	
587	6810-ZO-250-7888	Sodium Silicate Solution	Kg	
588	6810-99-220-0733	Sodium Sulphate Anhydrous AR (500 Gram Btl)	Btl	
589	GP-GENSTO-08094	Solder lead tin alloy bar 300 mm lg grade b	Kg	
590	BD-7093130	Spanner 1/2x7/16	Nos	
591	NIV	Spanner 32 x 64for 37 mm Gun	Nos	
592	31-AX-395	Spanner 36-41 mm	Nos	
593	NIV	Spanner 46-50	Nos	
594	NIV	Spanner 60 mm	Nos	
595	BD-7080805	Spanner Adjustable 12"	Nos	
596	Q10512-1	Spanner Combination 10mm	Nos	
597	Q10602-1	Spanner Combination 13mm	Nos	
598	Q10573-1	Spanner Combination 14mm	Nos	
599	Q10492-1	Spanner Combination 17mm	Nos	
600	Q10494-1	Spanner Combination 19mm	Nos	
601	Q10497-1	Spanner Combination 22mm	Nos	
602	GP-VEHTA-04744	Spanner Combination 24mm	Nos	
603	N7-391005-B	Spanner D/E 10x12 MM	Nos	
604	9-85112-142-0	Spanner D/E 14x17 MM	Nos	
605	NIV-0708	Spanner D/E 6 x 7	Nos	
606	NIV-0708	Spanner D/E 14 x 15	Nos	
607	NIV-0684	Spanner D/E 18 x 19	Nos	

Ser	Part No	Nomenclature	A/U	Rate
608	NIV-0357	Spanner D/E 8 x 10	Nos	
609	NIV-MT-000132	Spanner D/E 12 x 14	Nos	
610	NIV-MT-000132	Spanner D/E 17 x 19	Nos	
611	NIV-MT-000132	Spanner D/E 22 x 24	Nos	
612	NIV-MT-000132	Spanner D/E 24 x 27	Nos	
613	GP-VEHTA-04378	Spanner D/E 1/2 x7 7/16	Nos	
614	5120-ZO-150-5491	Spanner D/E 10 x 11MM	Nos	
615	30104744	Spanner D/E 10x11	Nos	
616	09140-00050	Spanner D/E 10x11, 12x14, 13x17, 19x22 & 24x27	Set	
617	30106393	Spanner D/E 12 x 14	Nos	
618	30104823	Spanner D/E 12x13	Nos	
619	30106395	Spanner D/E 17 x 19	Nos	
620	30100884	Spanner D/E 22 x 24	Nos	
621	30101963	Spanner D/E 24 x 27	Nos	
622	30102490	Spanner D/E 8 x 10	Nos	
623	003-110-012-003	Spanner D/E Open Jaw 12 x 13MM	Nos	
624	003-110-012-003	Spanner D/E Ring 12x13MM	Nos	
625	16574537	Spanner D/E Ring 19x22MM	Nos	
626	P1830-6	Spanner D/E Ring 6x7	Nos	
627	FA-17096	Spanner Open D/E 5/8 x 9/16MM	Nos	
628	NIV	Spanner Set Fix 10 to 20	SET	
629	NIV-0051	Spare Wheel Carrier Handle	Nos	
630	NIV	Spark Lighter	Nos	
631	NIV	Spark Plug Cleaner	Nos	
632	5120-ZO-153-2508	Spnr T Handle 10/12"	Set	
633	5120-ZO-150-5491	Spnr Open 10x11mm	Nos	
634	NIV	Spnr Open 11x13mm	Nos	
635	003-110-012-003	Spnr Open 12x13mm	Nos	
636	NIV-0683	Spnr Open 8x9mm	Nos	
637	09020-10285	Spnr Open End Different Type	Set	
638	NIV-MT-000132	Spnr Ring Type Diff Type	Set	
639	7360-ZO-250-9445	Spoon Large 45 Men Set	Nos	
640	3740-ZO-250-9212	Spray Hand Pump (for mosquito Spray)	Nos	
641	3740-ZO-250-9208	Sprayers Hand General Purpose Insecticide (Brass)	Nos	
642	NIV	Steel Box with Tray	Nos	
643	NIV	Steel rear buffers	Set	
644	GL-5-62-1	Steel Ruler 1ft	Nos	
645	NIV	Steel Straight Edge	Nos	
646	GP-GENSTORE-23553	Sticker Sheer Diff Color	Nos	
647	7105-ZO-250-1279	Stool Folding Mk-1	Nos	
648	UN-251-1705-1207	Storage Tank 2000 Ltr ,400 Gln(AI Ghazi)	Nos	
649	UN-251-1705-1208	Storage Tank 2400 Ltr ,500 Gln White (AI Ghazi)	Nos	
650	7310-ZO-150-6800	Stove Kerosene Burner 45 Men Set Complete	Nos	
651	7310-ZO-150-7369	Stove Kerosene Burner 4-6 men	Nos	
652	7310-ZO-150-2008	Stoves Slow Combustion 14000 CU Ft 12 Dia x 30 Height x 6 Flue Nozzle	Nos	
653	NIV	Strainer	Nos	
654	NIV	Stretcher Folding Type for Veh	Nos	

Ser	Part No	Nomenclature	A/U	Rate
655	NIV	Stretcher Safety Belt (Set of 2 Pcs)	Nos	
656	6530-ZO-150-3630	Stretcher Trolley for Hosp Use	Nos	
657	6520-ZO-250-2364	Stretcher, Folding, Folding Pole	Nos	
658	CN/PCN/0002/W	Strip Chin for Steel Helmet USA Pattern	Nos	
659	8465-257-3840	Strip Safety Sky for Lt Wt Helmets	Nos	
660	1015-00-034-4842	Strip Tie Down	Nos	
661	UN-251-1703-0960	Stud Button for Brass (Steel Helmet USA Pattern)	Nos	
662		Suction Pipe 20 Ft, Dia 5 Inch	Nos	
663	6810-ZO-250-7890	Sulphuric Acid, Pure	Lit	
664	KF/UN-250-0055	Syphon Dish (Best Quality)	Nos	
665	UN-251-1704-1186	Syphon Dish Trolley	Nos	
666	GP-VEHTA-05571	T Handle 3/4 Driver	Nos	
667	7105-ZO-250-4670	Table Folding Legs Steel Folding	Nos	
668	3770-ZO-250-6247	Tank Drinking Water Mule	Nos	
669	3770-ZO-250-6254	Tank Drinking Water Mule Cover	Nos	
670	3770-ZO-250-6255	Tank Drinking Water Mule Net	Nos	
671	3770-ZO-250-6256	Tank Drinking Water Mule Pipe	Nos	
672	NIV	Tank Fabric 1350 Gal	Nos	
673	NIV	Tank Fabric 50 Gal	Nos	
674	NIV	Tank Fabric 500 Gal	Nos	
675	5430-ZO-250-1295	Tank Fabric Collapsible 228 Lit (50 Gal)	Nos	
676	7320-ZO-150-8140	Tank Pressure Cap Filling Assy	Nos	
677	7310-ZO-150-8129	Tank Pressure Valve Control Blow Lamp	Nos	
678	7310-ZO-150-8142	Tank Pressure Valve Cyl Gas	Nos	
679	GP-AMMO-02768	Tape Adhesive	Nos	
680	5970-ZO-212-1158	Tape Insulating 1/2"	Nos	
681	WB-0967	Tape Insulating 1/2"-25 Yds (Nito)	Nos	
682	5970-ZO-212-2068	Tape Insulation 3/4"	Nos	
683	5970-99-040-4454	Tape Insulation 3/4" 25 YDS (NITO)	Nos	
684	5970-ZO-212-1156	Tape Insulation Cohon Self Adhesive 13mm 1/2"	Nos	
685	5970-ZO-212-1155	Tape Insulation Cohon Self Adhesive 19mm 3/4"	Nos	
686	8315-ZO-250-0964	Tape Newar White 51 MM (2")	Mtr	
687	8315-ZO-250-0966	Tape Newar White (BCC No.1) 51 MM(55 Mtr Roll)	Mtr	
688	65910-61100	Tarpaulin Assy (Trk ¼ ton 4x4 Land Cruiser HZJ-70	Nos	
689	2540-00-587-2352	Tarpaulin Size 12' x 17' APC	Nos	
690	7360-ZO-250-9446	Tawa 45 Men Set	Nos	
691	EI-7320-777	Tea Pot 10 Lit for 50 Pers	Nos	
692	KF/GS&C-251-0446	Tea Pot 20 Lit for 100 Pers	Nos	
693	KF/GS&C-251-0448	Tea Pot 30 Lit for 150 Pers	Nos	
694	NIV	Tech Manual	Nos	
695	KG/PKG-1328	Teflon Tape (Thread Seal Tape)	Nos	
696	8340-ZO-250-9773	Tent Latrine Complete	Nos	
697	8340-ZO-250-1331	Tent Op	Nos	
698	PJA-0470	Tents, Shelter Shamyana, 40 Ft x 20 Ft Mk-1 Complete	Nos	
699	5120-00-061-4047	Test Hammer	Nos	
700	6830-ZO-250-9279	Tetra Flouroethane Refrigerant Gas R-134 with cyl	Kg	
701	5120-ZO-153-2508	T-Handle	Nos	

Ser	Part No	Nomenclature	A/U	Rate
702	KD/UN-250-0236	Thermos (Recal)	Nos	
704	H1/8010-ZO-250-0209	Thinner for Paint	Lit	
709	8310-ZO-250-0416	Thread 10/3 Green	Pkt	
711	NIV	Three Jawa Gear Puller with Rod	Set	
712	5510-ZO-250-8144	Timber Deodar 25.4 MM x 254 MM x 274.32 CM and up	CUM	
713	5510-ZO-250-8145	Timber Deodar 31.75 MM x 215.9 MM x 274.32 CM and up	CUM	
714	5510-ZO-250-8147	Timber Deodar 38.1 MM x 203.2 MM x 274.32 CM and up	CUM	
715	5510-ZO-250-8149	Timber Deodar 38.1MM x 254 MM x 274.32 CM and up	CUM	
716	5510-ZO-250-8150	Timber Deodar 50.8MM x 254 MM x 274.32 CM and up	CUM	
717	NIV	Tommy Rod	Nos	
718	CF22X	Toner Cartridge for HP Laser Jet 26X High Yield Black	Nos	
719	GP-VEHTA-05173	Tool Bag	Nos	
720	912035110	Tool Bag Canvas	Nos	
721	5120-153-32799	Tool Box Steel	Nos	
722	30105592	Tool Box Steel Portable	Nos	
723	1010-ZO-101-4332	Tool Combination	Nos	
724	1010-ZO-101-4335	Tool Trigger & Firing Mech	Nos	
727	X5/PXE/0081/A	Torch Elec Hand Rechargeable	Nos	
728	6230-74-216-2992	Torch Hand Elec All Types	Nos	
729	2540-767-3149	Tow Rope Assy	Nos	
730	7210-ZO-250-4754	Towel Bath Cotton Size Large (60" x 32")	Nos	
731	KC/7210-ZO-250-4756	Towel Bath Small	Nos	
732	KC/7210-ZO-250-4757	Towel Hand Operating Green	Nos	
733	KC/7210-ZO-250-4756	Towel Operating Mk-2	Nos	
734	PBA4-127-171	Towing Bar	Nos	
735	KC/PKC-6402	Traffic Baton	Nos	
736	UN-250-0340	Trolley Bag (Ruck Sack)	Nos	
737	E3/3990-ZO-153-4501	Trolley, MIC, L-5800, W-1200, H-700 mm	Nos	
738	E3/3990-ZO-153-4500	Trolley, MIC, Parking Support, L-5700, W-2500, H-950 mm	Nos	
739	E3/3990-ZO-153-4502	Trolley, MIC, Parking Support, Roll On / Off	Nos	
740	E3/3990-ZO-153-4503	Trolley, MIC, Transfer Within Warehouse, L-2900, W-3100, H-3600 mm	Nos	
742	8010-ZO-250-7893	Turpentine Oil	Lit	
743	NIV	Two Jawa Gear Puller (H-113)	Nos	
744	NIV	Two Jawa Gear Puller (Screw Type)	Nos	
745	NIV	Two Jawa Puller H-85	Nos	
746	NIV	Tyre Busters	Nos	
747	4730-99-801-0902	Tyre Inflation Hose 25 m	Nos	
748	NIV	Tyre inflator with gauge	Nos	
749	NIV	Tyre Lever	Set	
750	NIV	Tyre Lever Set of Two Pcs	Nos	
751	5180-00-62-7052	Tyre Presage Gauge	Nos	
752	GP-F1/PFA-6335	Tyre Removing Kit for MT	Kit	

Ser	Part No	Nomenclature	A/U	Rate
753	GP-VEHTA-07368	Universal Plier	Nos	
754	5120-00-293-7397	Universal Plier Slip Joint	Nos	
755	8465-ZO-250-1388	Valises Bedding Officer	Nos	
756	7310-ZO-250-8734	Valve Con MK-3	Nos	
757	KG-4210-ZO-153-2955	Valve for DCP Cyl 05 Kg	Nos	
758	KG-4210-ZO-153-2956	Valve for DCP Cyl 50 Kg	Nos	
759	8010-ZO-250-0215	Varnish Oil	Lit	
760	8010-ZO-250-0214	Varnish Oil Brunswick Black 1 Lit	Lit	
761	7320-ZO-251-0287	Vegetable Slicer Machine	Nos	
762	CN/UN/251-1611-0536	Velcro Tape 1" Olive Green	Mtr	
763	CN/1807-1650	Velcro Tape 2" Olive Green	Mtr	
764	CA/8455/ZO-250-0867	Velcro Tape 3" Olive Green	Mtr	
765	CA/8455/ZO-250-0865	Velcro Tape 4" Olive Green	Mtr	
766	KF/1803-1543	Vermicelli's Machine	Nos	
767	NIV	Vernier Caliper Digital	Nos	
768	NIV	Vernier Caliper Scale	Nos	
769	NIV	Vernier Caliper with Depth Gauge	Nos	
770	NIV	Vest Summer	Nos	
771	30101815	Vibromax Instruction Manual W752 C	Nos	
772	30101815	Vibromax Service Catalogue	Nos	
773	GP-VEHTA-00933	Vibromax Service Manual W752 C	Nos	
774	NIV	V-Towing Bar pin	Nos	
775	NIV	Waist Coat for khateeb	Nos	
776	KA-6530-74-251-0323	Ward Screen 3 x Fold	Nos	
777	-	Warning Triangle (Foton D/Cabin)	Nos	
778	PKG-0046	Washer Cyl DCP 50 Kg (2-1/2")	Nos	
779	GP-13206	Washer Leather	Nos	
780	8310-ZO-150-7083	Washer Shoulder Cap Filing	Nos	
781	UN-MSN-0502	Washer Shoulder Pump for Oil Cooker	Nos	
782	8305-ZO-250-0990	Waste Cotton Colored	Kg	
783	CN/PCN/0021/W	Web Strip Chin / Strip Harness	Nos	
784	G2/PGB/0081/MS	Welding Rod Nos 10 S.S	Pkt	
785	NIV-MT-000150	Wheel Brace 27x30 (Germany)W/Handle	Nos	
786	GP-VEHTA-04813	Wheel Brass with Handle	Nos	
787	NIV	Wheel Brass with Handle for 37 mm Gun	Nos	
788	6530-ZO-150-1570	Wheel Chair for Hosp (Best Quality)	Nos	
789	NIV	Wheel Chock	Nos	
790	GP-VEHTA-04378	Wheel Chock	Nos	
791	54-23-54	Wheel Nut with Handle	Nos	
792	NIV	Wheel Spanner 30 X 32 mm	Nos	
793	9390-ZO-250-9222	Wick 15.87 MM	Mtr	
794	-	Wireless Antenna (Foton D/Cabin)	Nos	
795	NIV	Wooden block 1 ft x 1 ft	Nos	
796	NIV	Wrench (Spanner OJDE 36mm)	Nos	
797	NIV	Wrench (Wheel Brace) 36/27	Nos	
798	09020-10285	Wrench 3/8x7/16, 1/2x9/16, 5/8x11/16	Set	
799	NIV	Wrench Adjustable 10"	Nos	
800	5120-ZO-150-5483	Wrench Adjustable 12"	Nos	

Ser	Part No	Nomenclature	A/U	Rate
801	5120-264-3796	Wrench Adjustable 8"	Nos	
802	NIV	Wrench Combination 10,13,15,16,17,19,22,24,27,30x32,36x41mm	Set	
803	5120-00-935-4654	Wrench Drain Plug	Nos	
804	NIV	Wrench Filter	Nos	
805	NIV	Wrench L Type	Nos	
806	NIV	Wrench Plug Skt	Nos	
807	NIV	Wrench Skt No-21	Nos	
808	NIV	Wrench Skt No-22	Nos	
809	NIV	Wrench Skt No-23	Nos	
810	NIV	Wrench Skt No-23	Nos	
811	NIV	Wrench Skt No-24	Nos	
812	NIV	Wrench Skt No-26	Nos	
813	NIV	Wrench Skt No-26	Nos	
814	NIV	Wrench Skt No-29	Nos	
815	-	Wrench Socket 12mm	Nos	
816	-	Wrench Socket 14mm	Nos	
817	-	Wrench Socket 17mm	Nos	
818	-	Wrench Socket 19mm	Nos	
819	-	Wrench Socket 22mm	Nos	
820	-	Wrench Spr DE 10x12	Nos	
821	-	Wrench Spr DE 12x14	Nos	
822	-	Wrench Spr DE 14x16	Nos	
823	-	Wrench Spr DE 18x24	Nos	
824	-	Wrench Spr DE 27x30	Nos	
825	-	Wrench Spr DE 5x6	Nos	
826	-	Wrench Spr DE 7x8	Nos	
827	-	Wrench Spr DE 8x10	Nos	
828	30106416	Wrench Wheel Brace	Nos	
829	30102817	Wrench Wheel Nut With Handle	Nos	
830	NIV	Wrench-L 4,5,6,8,10,11,12,14mm	Set	
831	NIV	PET Straps Plastic for Fastening of Amo Plastic Pallets	Roll	
832	GP-GENSTO-13536	Sprayers, Shoulders-15.91 Liter, Mk-1 Washer Nozzle Jet	Nos	
833	GP-CLO-00238	Bag Kit Universal	Nos	
833	GP-Gensto-22049	Stool Fancy	Nos	
834	GP-GENSTO-03523	Tool Kit Carpenter Engineer Square Drive	Nos	
835	GP-CLO-00238	Collar Shirt Van Heusen Khaki Size 7 & 8	Nos	
836	Kit-10004	Socks Wool / Nylon Blended Green	Prs	
837	Kit-100024	Shirt men Cellular Men Khaki	Nos	
838	GP-CLO-002333	Apron Cooks	Nos	
839	GP-VEHTA-06731	Wrench Key Set Socket Head Screw 8 Men	Nos	

TENDER ORDNANCE STORES

Ser	Nomenclature	A/U
1.	Adaptor lh Offset Fork	Nos
2.	Adaptor rh Offset Fork	Nos
3.	Adjustable Spanner 18 mm	Nos
4.	Adze Head, Half Head (Tesa) Mild Steel Type 3.5 Lbs	Nos
5.	Air Conditioner Window Type 220/230 V, Single Phase, 1.5 Ton with accessories (General, USA) or equivalent	Nos
6.	Allen Key 14mm	Nos
7.	Anti Virus CDs	Nos
8.	Ashtray Crystal	Nos
9.	Badminton Set (2x Pole Iron 3", 2x Racket Head, 1 x Net Local, 12 x Shuttle Cock Swallow)	Set
10.	Barber Bag	Nos
11.	Bar-B-Que Seekh made of Iron, Length 3ft	Nos
12.	Base Ball Bat made of Wood , 2.9 ft Length, Dia 6"	Nos
13.	Basket Ball	Nos
14.	Bed Side Table Size-18" x 16" x 23" with 2x Daraz & Top Glass	Nos
15.	Bicycle Tube Rubber Size -24" (Servis) or equivalent	Nos
16.	Binder Clip Large Size	Pkt
17.	Binding Wire made of Iron, Size 1.5 mm	Kg
18.	Blade (Treet) or equivalent	Pkt
19.	Body Bag	Nos
20.	Bracket Steel for Wash Basin Set of 2 Pcs	Nos
21.	Brush 2 x 25	Nos
22.	Brush 7 x 50	Nos
23.	Brush Dust	Nos
24.	Brush for Washing Clothes	Nos
25.	Bubble Wrapping Sheet Size-Length – 50 yards, Width – 40 inch	Roll
26.	Bulb SOGO Search Light	Nos
27.	Bush 1" x ¼" GI (TG, China) or equivalent	Nos
28.	Bush Carbon Cutter Machine	Nos
29.	Bush Carbon Grinder Machine	Nos
30.	Cable Digital Multimeter Unit	Nos
31.	Cap Protective G3A3	Nos
32.	Card Sheet (Brown, Blue, Red, Green, & Black) Pearlescent Card Pkt of 5	Nos
33.	Cardboard Sheet Size-6'x3'x3 Sooter	Nos
34.	Carton 7 Ply 2' x 2' x 3'	Nos
35.	Carton 7 Ply 2.5' x 3.5' x 3'	Nos
36.	Carton 7 Ply 3' x 3' x 2'	Nos
37.	Carton 7 Ply 3.5' x 2' x 2'	Nos
38.	Case Knife Pocket No.1	Nos
39.	Cell 1.2 Amp	Nos
40.	Cell Rechargeable Type C 1.5 V (Energizer) or equivalent	Nos
41.	Cell Rechargeable Type D 1.5 V (Energizer) or equivalent	Nos
42.	Chair Hair Cut Size- 26.5" x 23" x 44" Height with Foot Rest	Nos
43.	Charging Cable PRC-77	Nos
44.	Choke Tube Light 20 Watt (Philips) or equivalent	Nos

Ser	Nomenclature	A/U
45.	Choke Tube Light 40 Watt (Philips) or equivalent	Nos
46.	Cleaning Brush G3A3	Nos
47.	Cleaning Kit	Nos
48.	Cloth Abrasive Emery Grade-I	Qrs
49.	Cloth Cleaning for Vehs	Nos
50.	Cloth Malmal	Mtr
51.	Colour Flag	Pkt
52.	Colour Printer Desk Jet Latest Model with CD, Data & Power Cables	Nos
53.	Compound Polish	Kg
54.	Connecting Cable for Fuel Tlr 3500 Lits	Nos
55.	Connecting Cable for Tlr 10-CWT	Nos
56.	Connecting Cable for Tlr M-104	Nos
57.	Connecting Cable for Water Tlr 3500 Lits	Nos
58.	Connecting Cable for Water Tlr 400 Glns	Nos
59.	Cover Water Proof 30' x 30'	Nos
60.	Cricket Bat for Tennis Ball	Nos
61.	Cricket Set (2x Bats CA, 2x Stumps Set Mattel Base with Bells)	Nos
62.	Crow Bar Chisel & Claw 6' x 1-1/2" Round	Nos
63.	Crow Bar Chisel & Claw 8' x 1-1/2" Round	Nos
64.	Cutter Blade Steel 9 Inch	Nos
65.	Cutter Disc 9/14"	Nos
66.	Cutting Knife Set	Nos
67.	D Link Switch 10 Port	Nos
68.	Daigcha 18 inch with Lid (Sonex) or equivalent	Nos
69.	Daigcha 24 Inch with Lid (Sonex) or equivalent	Nos
70.	DDT Spray Machine 8 Lits	Nos
71.	De Soldering Pump (Sucker) or equivalent	Nos
72.	Decoration Lts 30 ft Length	Nos
73.	Dialing Phone Set (Panasonic) or equivalent	Nos
74.	Diesel Timing Lab	Nos
75.	Dimmer Lamp for Lighting Set	Nos
76.	Dish Receiver Complete with 1 Year Card Internet Port Wifi 3G and GPRS Sim Card Plug and Play online replace, list manual code and auto code all in line (Star Track) or equivalent	Set
77.	Dozi Pump	Nos
78.	Dust Bin Wh for Garbage	Nos
79.	Elbow 1 1/4" GI (TG, China) or equivalent	Nos
80.	Elbow Protection	Prs
81.	Elec Wire Black (DC Wire Black)	Roll
82.	Elec Wire Red (DC Wire Red)	Roll
83.	Electric Geyser Capacity 15 Gallons (Crown) or equivalent	Nos
84.	Electric Welding Rod No.12 (Zodian) or equivalent	Pkt
85.	Erasable Marker 90 Nos (Red, Green, Blue, Black)	Nos
86.	Face Mask	Pkt
87.	Feed Pump 1.5 HP (7.5 A) 1500 Watt	Nos
88.	File Round 6"	Nos
89.	Fire Ext 02 Gln Soda Acid Charges	Nos
90.	Flash / Spot Lts made of Steel with Glass in front of Light, 15 Watt	Nos
91.	Flex Welding Bronze Phosphor	Kg
92.	Float Valve 1"	Nos

Ser	Nomenclature	A/U
93.	Float Valve 1-1/4"	Nos
94.	Float Valve 1-1/2"	Nos
95.	Fly Outer Tent 180 Lbs	Nos
96.	Fork - JCO / Offrs Mess	Nos
97.	Fumigation Machine Fogger (Model-TS35A, China) or equivalent	Nos
98.	Gas Cork Brass Size 1/2" (Eagle) or equivalent	Nos
99.	Gas Welding Rod made of Brass, standard length (Zodian) or equivalent	Kg
100.	Gasket	Nos
101.	Gauze for Washing Utensil	Nos
102.	Glass Stainless Steel	Nos
103.	Guzz Wooden Length 8'x 2.5", 1.5" thickness	Nos
104.	Hair Cleaning Brush	Nos
105.	Hair Cutting Cloth Made of Polyester Size 45"x47", Neck Size-18"	Nos
106.	Hair Cutting Machine Electric (Dingling Model RF-609) or equivalent	Nos
107.	Hair Cutting Machine Manual	Nos
108.	Hammer 1 Kg	Nos
109.	Hammer 1/2 Kg	Nos
110.	Hammer 2 1/2 Kg	Nos
111.	Hammer 2 Kg	Nos
112.	Hammer Ferrier Mason 5 Lbs	Nos
113.	Hand Spring Grip Set of 2 Pcs	Nos
114.	Handle Valve 1-1/4" GI	Nos
115.	Hanger Pati for Wall Wooden Size 2.5'	Nos
116.	Helmet Riot Control with Visor	Nos
117.	Holder Reflector Light	Nos
118.	Holding Holder Pin Type	Nos
119.	Iron / Steel Bucket Large Size	Nos
120.	Iron Electric 5 Kg for Dhobi	Nos
121.	Iron Table Folding Wooden with Iron Stand for Dhobi	Nos
122.	Jacket Riot Control	Nos
123.	Jamboor	Nos
124.	Jay-e-Namaz	Nos
125.	Job Folder Capacity 100 Cards	Nos
126.	Jogging Machine 2 HP Motor (Slimline TA5211 China) or equivalent	Nos
127.	Jost Fifth Wheel Operating Instructions Trk9 Ton Prime Mover M/Benz 2336 A 6x6	Nos
128.	Jug Crystal	Nos
129.	Jug Glass (Toyo Nasic) or equivalent	Nos
130.	Jug Stainless Steel	Nos
131.	Karum Board made of Size Std with Stand & accessories	Nos
132.	Knee Protection	Prs
133.	Knob for Tee Cork Plastic	Nos
134.	Lamination Sheet 4'x8'x3/4"	Nos
135.	Lamination Slide Cover	Nos
136.	Lamp H/C Hand	Nos
137.	Lamp Holder Lock Nut for Lighting Set	Nos
138.	Lamp Incandescent	Nos
139.	Lighting Set Ground Illumination 25 Out Let	Set
140.	Lock Pin Set	Nos
141.	Looking Mirror 2'x2' with Frame	Nos

Ser	Nomenclature	A/U
142.	Lub Grease MP-1	Nos
143.	Main Switch Elec 500V, 60 Amp	Nos
144.	Male / Female Shoe & Socket	Dzn
145.	Max Pro Tow Eye Adaptor	Nos
146.	Mic / Head Phone Cable Length 2.2 Mtr, Input Power 50 MW, Frequency 20 Hz-20000 Hz (Audionic/ A4 Tech) or equivalent	Nos
147.	Mirror 3'x2' with Frame	Nos
148.	Molten lava	Nos
149.	Motor Capacitor (Feed Pump) 40 UF	Nos
150.	Motor Capacitor (Pressure Pump) 50 UF	Nos
151.	MRV Live Air Kit	Nos
152.	Nail Common Wire 2-1/2"	Kg
153.	Nail Common Wire 1/2"	Kg
154.	Nail Common Wire 6"	Kg
155.	OFC Patch Card 3 Mtr SC	Nos
156.	Office Carpet 15' x 10' Synthetic (Turkey)	Nos
157.	Oil Can 0.3 Lit	Nos
158.	On/Off Button 32 Amp for Sogo Search Light	Nos
159.	Operating Light Mobile Type 4 Reflectors with Emergency Bty Box	Nos
160.	PA Eqpt (1 x Amplifier, 6 x Mics, 2 x Collar Mics, 2 x Speakers, 2x Horn Unit, 2x Stand, 4x Tee, & 100 Mtr Wire 40/76 Copper) (Dolphen) or equivalent	Nos
161.	Packing Clip Machine	Nos
162.	Packing Cotton	Kg
163.	Packing Lock Strap	Pkt
164.	Packing for Gasket	Nos
165.	Paper Tape 2"	Nos
166.	Pen Stand Set	Nos
167.	Perfumed Powder (Black Cat) or equivalent	Btl
168.	Permanent Marker 90 Nos Balck (Dollar) or equivalent	Nos
169.	Phosphor Bronze Rod Round 5 mm Dia	Kg
170.	Picket Angle Mild Steel Size 4'	Nos
171.	Pipe Hook 1" for GI Pipe	Nos
172.	Pipe Hooks Plastic (Clips)	Pkt
173.	Plastic Bottle	Nos
174.	Plastic Box	Nos
175.	Plastic Lock Strap (Chapping)	Nos
176.	Plastic Round Wiring Pipe 1" Length 10 ft	Nos
177.	Plastic Sheet 1'x1'x1 Sooter	Roll
178.	Plug 2 Pen Shoe (Male / Female)	Dzn
179.	Plug for Iron (Male / Female)	Nos
180.	Plug PVC 3/4"	Nos
181.	Plug Repair Patches	Box
182.	Poles Foot Ball with Net	Nos
183.	Police Stick	Nos
184.	Pressure Cooker 11 Lit (Sonex) or equivalent	Nos
185.	Pressure Cooker 25 Lit (Sonex) or equivalent	Nos
186.	Pressure Cooker 7 Lit (Sonex) or equivalent	Nos
187.	Pressure Pump 2 HP (15 A) 2200 Watt	Nos
188.	Printed Hock Adapter Kit	Nos
189.	Prisn with Poll	Nos

Ser	Nomenclature	A/U
190.	Protecting Cover (Shield) Oscilloscope	Nos
191.	Protecting Shield Transparent Hard Plastic Sheet. Thickness of Shield is 3mm. Length 3'.3", Width 1'.8", Handle to Hold the Screen	Nos
192.	PSP Sheet Size- 10' x 15", 10 SWG	Nos
193.	PVC Cable 5 Prs	Nos
194.	PVC Packing Roll Length – 300 Mtr	Roll
195.	PVC T Joint Size 1"	Nos
196.	Quick Action Clamp Dia 2"	Nos
197.	Quick Action Clamp Dia 3"	Nos
198.	Radial Tyre Repair Patches	Box
199.	Radium	Btl
200.	Rake Hoe Attachment	Nos
201.	Rate Killer Tablets/ Poison	Pkt
202.	Reconditioned Radom Policy Size TW No.098110	Nos
203.	Reducer Elbow GI 2.5"x2" (TG, China) or equivalent	Nos
204.	Reducer Elbow GI 2"x1.5" (TG, China) or equivalent	Nos
205.	Reducer Socket GI 2.5"x2" (TG, China) or equivalent	Nos
206.	Reducer Tee GI 2.5"x2" (TG, China) or equivalent	Nos
207.	Reel for Cable	Nos
208.	Respirator Maintenance & User Hand Book	Nos
209.	Ribbon ½" different Colour	Dzn
210.	Ribbon 1" different Colour	Dzn
211.	Ribbon 2" different Colour	Dzn
212.	Rivet ¼" x 1"	Pkt
213.	Rivet 1.5 Inch	Pkt
214.	Rivet 3/8" x ¾"	Pkt
215.	RJ 11 Connector	Nos
216.	Roller Pen Set (Blue, Green, Red, Black)	Nos
217.	Rostrum Glass	Nos
218.	Rostrum Wooden	Nos
219.	Safe Orderly Room	Nos
220.	Sakka Folding Tube Mild Steel Size 18' x 3"	Nos
221.	Salitha FA	Nos
222.	Salphen Paper	Nos
223.	Sand Paper P-180	Nos
224.	Sand Paper P-80	Nos
225.	Scissor Hair Cutting	Nos
226.	Scotch Tape ½" (Johnson) or equivalent	Nos
227.	Screw 1" Black (Adam Jee) or equivalent	Pkt
228.	Screw 2" Black (Adam Jee) or equivalent	Pkt
229.	Screw Driver Cab Combination 3	Nos
230.	Security Light On/ Off Button 32 Amp	Nos
231.	Shaving Cream	Nos
232.	Shoulder Protection	Prs
233.	Show Case Wooden Size - 5' x 4' x 30"	Nos
234.	Silver Wind Shield Reflector Cover	Nos
235.	Single Rod Stainless Steel for Bench Press with Stopper and Weight Plates Made of Iron 2,5,10 and 20 Kg (2xPlates of each Size)	Set
236.	Skua	Nos
237.	Slash Dana	Kg

Ser	Nomenclature	A/U
238.	Slicer / Kadokush Stainless Steel	Nos
239.	Slide Sheet	Pkt
240.	Sling for G3A3	Nos
241.	Socket 2 mm	Nos
242.	Sohaga Powder for Gas Welding	Kg
243.	Soldering Iron 100 W	Nos
244.	Sooter Dori (Roll)	Roll
245.	Soup Set Offr Mess 12 Men (Ceramic)	Nos
246.	Special Kong	Nos
247.	Special Kong	Nos
248.	Stack Ground Military	Nos
249.	Steel Almirah 6' x 4'	Nos
250.	Steel Razor (Ustra)	Nos
251.	Stick Pointer Steel 4 ft	Nos
252.	Sticker Sheet Different Colors Size 22" x 28"	Nos
253.	Stove Electric with 4x Burner (Electric HOB, 4x Rating Plate)	Nos
254.	String Inserts	Box
255.	Strip Web	Nos
256.	Suction Pipe 2" x 50' with Brass Connector Male & Female	Nos
257.	Suction Pipe 3" x 50' with Brass Connector Male & Female	Nos
258.	Suff Carpet 50 Person	Nos
259.	Support Litter Folding Almn	Nos
260.	Surah Yaseen	Nos
261.	Sweet Spoon Stainless Steel	Nos
262.	Table Plastic	Nos
263.	Tank Processing Set X-Ray Film	Nos
264.	Tape Textile Cotton	Nos
265.	Tarzier Mini (NVD)	Nos
266.	Tea Cup with Saucer	Nos
267.	Tee Gl 1/2" (TG, China) or equivalent	Nos
268.	Tempo Marker (12x Diff Colours Set)	Pkt
269.	Tennis Ball (Dunlop) or equivalent	Nos
270.	Tennis Racket	Nos
271.	Thermos 1-1/2 Lit	Nos
272.	Tissue Paper Roll (Tulip) or equivalent	Nos
273.	Toner 107A for Laser Jet Printer	Nos
274.	Toner 17A & 19 A, 2 Pcs Set	Nos
275.	Toner 305 A for Laser Jet Printer	Nos
276.	Toner 61A, 2pcs Set	Nos
277.	Tonner 126A	Nos
278.	Tool Casing	Nos
279.	Towel Bath Cotton Size Large (60" x 32")	Nos
280.	Towel Bath Cotton Size Medium (54" x 27")	Nos
281.	Treadmill (Matrix, Model-TF70XR, 3HP AC Motor, USA) or equivalent	Nos
282.	Treadmill (Sole, Model-S77, 4HP AC Motor) or equivalent	Nos
283.	Treadmill (CIAPO, Model-CP-Q6, 4.5HP AC Motor) or equivalent	Nos
284.	Treadmill (Jogway, Model-CT-29, 5HP AC Motor) or equivalent	Nos
285.	Treadmill (RUNDW, Model-6840EA, 4HP AC Motor) or equivalent	Nos
286.	Treadmill (Advance Fitness, Model-6840EA, 4HP AC Motor) or equivalent	Nos
287.	Treadmill (Sports Art, Model-T673-16, 4HP AC Motor) or equivalent	Nos

Ser	Nomenclature	A/U
288.	Treadmill (Spirit, Model-CT-850, 6HP AC Motor) or equivalent	Nos
289.	Treadmill (Sports, Model-6068, 2HP AC Motor) or equivalent	Nos
290.	Tub Iron Large	Nos
291.	Tub Plastic Large	Nos
292.	Tweezer	Nos
293.	Tyre Puncture Machine	Nos
294.	Tyre Repair Patches	Box
295.	UC 150 Men Spoon Large	Nos
296.	UPT Cat-6 Cable (3M)	Nos
297.	USB 16 GB	Nos
298.	Visitor Chair	Nos
299.	Volley Ball Net	Nos
300.	Voltmeter (100 V to 500 V)	Nos
301.	VPS (Panasonic PT-VW360, 4000 Lumens) with allied Eqpt alongwith 30 Mtr VGA Cable (or equivalent)	Nos
302.	VPS Screen Size-80"	Nos
303.	Washing Soda	Kg
304.	Web Camera 16 Mega Pixel Lens, Driver Free Web Cam with Built in Microphone (A4 Tech/ Dany) or equivalent	Nos
305.	White Sheet Plastic	Nos
306.	Wiper Hand for Vehicle	Nos
307.	Wire Clip made of Plastic mix size	Pkt
308.	Wire Gauze	Mtr
309.	Wooden Polish	Btl
310.	Wrapping Plastic Roll Size-1.5'x1.5'x0.5 Sooter	Nos

TENDER ORDNANCE STORES - FY 2024-25

Ser	Nomenclature	A/U	Rate	Remarks
1.	Dean & Stark Apparatus DIN BS ASC	Nos		Specifications attached
2.	Quad Copter DJI M30T (DJI Enterprises) or equivalent	Nos		
3.	Quad Copter DJI M3T Thermal (DJI Enterprises) or equivalent	Nos		
4.	Argon Purification Cartridge for Optical Emission Spectrometer (Sertronic France) or equivalent	Nos		
5.	Water Trailers 2000 Lit	Nos		
6.	Water Trailers 3000 Lit	Nos		
7.	Water Trailers 4000 Lit	Nos		
8.	Water Trailers 5000 Lit	Nos		
9.	Water Trailers 6000 Lit	Nos		
10.	Water Trailers 7000 Lit	Nos		
11.	Digital Microscope X 1000	Nos		
12.	Melt Flow Index Tester ASTM-1238D ISO-1133	Nos		
13.	Tyre Changing Machine upto 10 Trk Ton incl Gun Tower (China) or equivalent Op Pressure – upto 130 BAR Max Rim Dia – 2400mm Max Rim Size 56"	Nos		-

Note

- **Brand/ Model and Country of Origin mentioned against each item.**
- **Trg / Instl of Eqpt be provided to user unit by firm concerned.**
- **Technical Specifications and Details of each item are attached.**
- **Technical offer and Commercial Offer will be submitted in separate envelopes and also indicate on each envelope about contents boldly i.e. Technical Offer and Commercial Offer. All these 2 x envelopes will be sealed in one large size envelope.**

PACKING REGIME
REPLACEMENT OF EXISTING PACKING INTO STD BOXES & CRATES

Ser	Item / Descriptions	Suggested Pkg Material	Dimension Of Pkg			No Of Items/Pkg
			L	W	H	
1.	Socks Men D/Knitted Khaki All Size	Card Board Carton (7 Ply)	22"	15"	13.5"	50
2.	Gloves Knitted Khaki All Size	-DO-	22"	15"	13.5"	120
3.	Cap Comforter Khaki	-DO-	22"	15"	13.5"	100
4.	Vest Men Khaki F/Sleeve All Size	-DO-	22"	15"	13.5"	40
5.	Jersey Men P/O All Size	-DO-	22"	15"	13.5"	15
6.	Pillow Bed Cover	-DO-	22"	15"	13.5"	200
7.	Pillow Polyester	-DO-	22"	15"	13.5"	2
8.	Net Mosquito	-DO-	22"	15"	13.5"	15
10.	Gown Operation All Size	-DO-	22"	15"	13.5"	50
11.	Durree blue 6"x3"	-DO-	22"	15"	13.5"	20
12.	Shirt Men White All Size	-DO-	22"	15"	13.5"	50
13.	Trouser All Size	-DO-	22"	15"	13.5"	50
14.	Bed Sheet Cotton	-DO-	22"	15"	13.5"	50
15.	Blanket Bed Gs	-DO-	22"	15"	13.5"	5
16.	Apron Hospital	-DO-	22"	15"	13.5"	50
17.	Field Cap (All Sizes)	-DO-	22"	15"	13.5"	200
18.	Kurta All Sizes	-DO-	22"	15"	13.5"	50
19.	Pajama All Sizes	-DO-	22"	15"	13.5"	50
20.	Rain Coat	-DO-	22"	15"	13.5"	20
21.	Liner Parka	-DO-	22"	15"	13.5"	20
22.	Liner Parka Trouser	-DO-	22"	15"	13.5"	20
23.	Parka Jacket	-DO-	22"	15"	13.5"	20
24.	Parka Trouser	-DO-	22"	15"	13.5"	20
25.	Jersey Men H/N	-DO-	22"	15"	13.5"	15
26.	Thermal Vest	-DO-	22"	15"	13.5"	20
27.	Thermal Drawers	-DO-	22"	15"	13.5"	20
28.	Down Trouser	-DO-	22"	15"	13.5"	04
29.	Socks HA	-DO-	22"	15"	13.5"	40
30.	Gloves Ha Woolen	-DO-	22"	15"	13.5"	100
31.	Cap C/W	-DO-	22"	15"	13.5"	50
32.	Chest Rig G3	-DO-	22"	15"	13.5"	10
33.	Frog For Scabbard	-DO-	22"	15"	13.5"	250
34.	Pouch Medium	-DO-	22"	15"	13.5"	100
36.	Cover Water Bottle	-DO-	22"	15"	13.5"	50
37.	Gloves Leather	-DO-	22"	15"	13.5"	10
38.	Rope Nylon 9mm	-DO-	22"	15"	13.5"	10
39.	Rope Nylon 11mm	-DO-	22"	15"	13.5"	08
40.	Strip Non Freezing	-DO-	22"	15"	13.5"	75
41.	Google HA	-DO-	22"	15"	13.5"	48
42.	Snap Link S/G	-DO-	22"	15"	13.5"	300
43.	Snap Link O/G	-DO-	22"	15"	13.5"	300
44.	Pulley Cm	-DO-	22"	15"	13.5"	100
45.	Ascender	-DO-	22"	15"	13.5"	120

46	Decender	-DO-	22"	15"	13.5"	120
47	Oxygen Cyl	-DO-	22"	15"	13.5"	04
48	Gamow Bag Ha	-DO-	22"	15"	13.5"	01
49	Sleeping Bag Ha	-DO-	22"	15"	13.5"	01
50	First Aid Kit	-DO-	22"	15"	13.5"	50
51	Chagul Water Carrying Universal	-DO-	22"	15"	13.5"	40
52	Drinking Mug	-DO-	22"	15"	13.5"	36
53	Un Beret Blue	-DO-	22"	15"	13.5"	72
54	Mess Tin With Food Pan	-DO-	22"	15"	13.5"	30
55	Gum Boot All Sizes	-DO-	22"	15"	13.5"	10
56	Tape Niwar	-DO-	22"	15"	13.5"	16
57	Cover Sight Infinity Reflex	-DO-	22"	15"	13.5"	60
58	Cover Course Head	-DO-	22"	15"	13.5"	35
59	Cover Canvas	-DO-	22"	15"	13.5"	40
60	Insulation Pad	-DO-	22"	15"	13.5"	50
61	Helmet Un Color	-DO-	22"	15"	13.5"	08
62	Pump Assy	-DO-	22"	15"	13.5"	50
63	Cover Jack	-DO-	22"	15"	13.5"	90
64	Cover Range Setter	-DO-	22"	15"	13.5"	65
65	Urinal Pot	-DO-	22"	15"	13.5"	02
66	Cover Sight And Feeder	-DO-	22"	15"	13.5"	03
67	Burner Assy	-DO-	22"	15"	13.5"	12
68	Helmet Riot Con	-DO-	22"	15"	13.5"	06
69	Helmet Fiber	-DO-	22"	15"	13.5"	08
70	Water Bottle	-DO-	22"	15"	13.5"	25
71	Vest Men Cotton H/S D/Color	-DO-	22"	15"	13.5"	85
72	Survival Kit	-DO-	22"	15"	13.5"	36
73	Bed Sheet Blue	-DO-	22"	15"	13.5"	40
74	Socks Worsted Olive Green	-DO-	22"	15"	13.5"	180
75	Towel Hand Bleached	-DO-	22"	15"	13.5"	20
76	Coverall Men Khaki	-DO-	22"	15"	13.5"	25
77	Elbow / Knee Pad	-DO-	22"	15"	13.5"	15
78	Waist Belt	-DO-	22"	15"	13.5"	180
79	Vest Men Cotton F/S O/Color	-DO-	22"	15"	13.5"	75
80	Vest Mess Cotton H/S O/Color	-DO-	22"	15"	13.5"	192
81	Sufi Soap 250 Gm	-DO-	22"	15"	13.5"	192
82	Urinal Steel	-DO-	22"	15"	13.5"	09
83	Plastic Sheet	-DO-	22"	15"	13.5"	120
84	Paint Green Gallon	-DO-	22"	15"	13.5"	06
85	Tent 2 Men Biv	Wooden Crate	34"	16"	10"	01
86	Tank Fabric Collapsible 2273 Lit 500	-DO-	23.5"	23.5"	14"	01
87	Tank Fabric Collapsible 228 Lit 50 Gal) Complete	-DO-	23.5"	23.5"	14"	05
88	Pauline 30X30	-DO-	45"	22"	11"	01
89	Pauline 24X24	-DO-	45"	22"	11"	01
90	Pauline 24X18	-DO-	45"	22"	11"	01
91	Pauline 20X5	-DO-	45"	22"	11"	01
92	Pauline 18X15	-DO-	45"	22"	11"	01
93	Pauline 15X15	-DO-	45"	22"	11"	01
94	Heater Assy Kerosene Oil Kerona	Card Board Carton (7 Ply)	18"	18"	22"	01

95	Heater Assy Kerosene Oil Fujika	-DO-	13"	13"	19"	01
96	Food Container Insulated 1 Gal Mk-2	-DO-	8"	8"	14"	01
97	SLEEPING BAG NORMAL	-DO-	22"	22"	14"	02
98	Extinguisher Fire Dcp 5 Kg	-DO-	7"	7"	21"	01
99	Tank Drinking Water Mule	Wooden Crate	23.5"	23.5"	20"	01
100	Lubricating Oil Om-11	-DO-	15"	15"	21"	01
101	Corrosion Privative Compound Px -1	-DO-	15"	15"	21"	01
102	Recoil Mechanism Fluid	-DO-	15"	15"	21"	01
103	Corrosion Prevent Oil Thin Film Px-4	-DO-	15"	15"	21"	01
104	Lubricating Oil Petroleum Compressor Light Om-58	-DO-	15"	15"	21"	01
105	Hydraulic Fluid Pet Base For Preservation & Operation Px-26	-DO-	15"	15"	21"	01
106	Net cam polyester multi cam pixilate pattern size 14'x14'	-DO-	41"	24"	14"	01
107	Net cam Polyester Multicam pixilate pattern size 26'x26'	-DO-	41"	24"	14"	01
108	Net Cam Polyester Multicam pixilate Pattern size 35'x35'	-DO-	41"	24"	14"	01
109	Ground Sheet Khaki	Card Board Carton 7ply)	22"	15"	7"	10
110	Tent 8 Men Complete Pole S 1+M	Wooden Crate	79"	10"	7"	10+10
111	Tent 8 Men Complete(Pole L)	-DO-	117"	10"	7"	6+1 POLE RIDGE
112	Tent 8 Men Complete(Piquet 3)	-DO-	39"	9.5"	5.5"	14
113	Tent 8 Men Complete(Fly In Out)	-DO-	50"	23"	15"	01
114	Tent 2 Men Complete Accy	-DO-	60"	12"	7"	IN PIECES
115	Tent 2 Men Complete (Fly In/Out	-DO-	40"	23"	12"	01
116	Combat Boot Black	-DO-	22.5"	45"	14"	12

Ser	Subj	Description
a.	Nomen of Eqpt	Dean & Stark Apparatus DIN BS ACS
b.	Picture	
c.	Test Method	ASTM D-95
d.	Description	<p>(1) Dean Stark Apparatus is an Azeotropic Distillation and useful way to remove a product, such as water, from a reaction mixture by co-distillation.</p> <p>(2) Typically consists of a vertical cylindrical glass tube, often with a volumetric graduation along its full length and a precision stopcock at its lower end, very much like a burette.</p>
e.	Use	<p>(1) The Eqpt is used to determine the water content of Petroleum Products, Tars and other bituminous materials according to the ASTM D-95.</p> <p>(2) The apparatus is based on the principle that water and an immiscible solvent like toluene or xylene distill off together at a constant ratio at a temperature lower than the boiling point of either component.</p>

Ser	Subj	Description
f.	Technical Specification	<p>The Eqpt comprises electric heater with thermo-regulator, glass still, support stand, condenser, receiving trap and clamp. Nec accessories are as under:-</p> <ol style="list-style-type: none"> (1) Single Unit Model (2) Core Sample Diameter: upto 1.5 Inch. (3) Core Sample Length: upto 4 Inch (4) Extractor Capacity: 250 ml (5) Boiling Flask: 500 ml (6) Receiving Tube: 5 and 15 ml, 0.1 ml graduation (7) Heating Temperature: upto 450°C (8) Water cooling System: 0.5 to 3 Litres per minute, 18°C (9) Power Supply: 220 VAC 50 Hz (10) Iron Stand with Clamp (11) ASTM Silicone Tube (12) ASTM Heater (13) Glass beads 500 gm
g.	Solvent Req	<ol style="list-style-type: none"> (1) ASTM Solvent Toulene Petro Chem England (2) ASTM Solvent Xylene Petro Chem England (3) ASTM Solvent Naphtha Petro Chem England (4) Toulene Analytical 2.5 Litres (5) Xylene Analytical 2.5 Litres (6) Iso-octane Analytical 2.5 Litres (7) Petroleum Ether – 2.5 Litres (100-120°C) Analytical (8) Petroleum Distillate Solvent

DJI M30T

Ser	Items	Specs
Aircraft		
1.	Aircraft	470x585x215 mm (LxWxH) (Unfolded w/o propellers)
2.	Design wheelbase	668 mm
3.	Wt	3770 gm (Approx) with 2x btys
4.	Max Ft altitude	5000 m (with 1671 propellers)
5.	Max Flt time	41 min
6.	Ingress protection rating	IP55
7.	Global Navigation Satellite System	GPS + GLONASS + BeiDou + Galileo
8.	Op Temp	-20 to + 50 degree Celsius
Remote Controller		
1.	Screen	7.02 LCD Touch Screen, Resolution 1920x1200 pixels, Max Brightness 1200 cd/m ²
2.	Global Navigation Satellite System	GPS + BeiDou + Galileo
3.	Built In Bty	Type: Li-ion (6500 mAH @ 7.2 V) Chemical Sys: LiNiCoAlO ₂
4.	External Bty (WB37 Intelligent Battery)	Capacity: 4920 mAH Voltage: 7.6 V Type: Li-ion Chemical Sys: LiCoO ₂
5.	Ingress protection rating	IP54
6.	Operating Time	Built In Bty: 3 hrs 18 min Built In Bty + External Bty: approx 6 hrs
7.	WIFI Protocol	WIFI 6
Video Tx		
1.	Video Tx sys	DJI O3 Enterprise Tx
2.	Antenna	4 video tx antennas, 2T4R
3.	Max Tx Dist (free of interference)	15 km (fcc) 8 KM (ce/ srcc/ mic)
Infrared Sensing Sys		
1.	Obs Sensing Rg	Fwd/ Backward/ Lt/ Rt: 0.1 – 10 m
Intelligent Flt Bty		
1.	Model	TB30
2.	Capacity	5880 mAH
3.	Voltage	26.1
Intelligent Bty Station		
1.	Dimensions	353x 267x 148 mm (LxWxH)
2.	Net Weight	3.95 Kg
3.	Compatible Items	store TB 30 Intelligent Flt Btys WB37 Intelligent Btys

DJI MAVIC 3T Thermal

Ser	Items	Specs
Aircraft		
1.	Aircraft	347.5x283x107.7 mm (LxWxH) (Unfolded w/o propellers)
2.	Diagonal Dist	380.1 mm
3.	Wt	920 g (Approx) without propellers/ accessories
4.	Max Ft altitude	6000 m (w/o payload)
5.	Max Flt time	45 min
6.	Ingress protection rating	IP55
7.	Global Navigation Satellite System	GPS + GLONASS + BeiDou + Galileo
8.	Op Temp	-20 to + 50 degree Celsius
Remote Controller		
1.	Screen	5.5 LCD Touch Screen, Resolution 1920x1080 , Max Brightness: 1000 nits
2.	Weight	Approx 680 g
3.	Global Navigation Satellite System	GPS + BeiDou + Galileo
4.	Built In Bty	Type: Li-ion (6500 mAH @ 7.2 V)
8.	WIFI Protocol	WIFI 6
Video Tx		
1.	Video Tx sys	DJI O3 Enterprise Tx
2.	Antenna	4 video tx antennas, 2T4R
3.	Max Tx Dist (free of interference)	15 km (fcc) 8 KM (ce/ srcc/ mic)
Vision Sys		
1.	Obs Sensing Rg	Fwd/ Backward/ Lateral: 0.5 – 20/ 0.5-16/ 0.5-25 m
Intelligent Flt Bty		
1.	Type	LiPo 4s
2.	Capacity	5000 mAH
3.	Voltage	15.4

SPECIFICATIONS – ARGON PURIFICATION CARTRIDGE FOR OPTICAL EMISSION SPECTROMETER

1. **General.** It is used for purification of Argon gas which provides inert media in Optical Emission Spectrometer for testing of samples.

2. **Technical Specifications**

a.	Purified Gas:	Argon
b.	Capacity:	250 Nm ³
c.	Compatibility:	Optical Emission Spectrometer, Model Minilab 150 (GNR Srl Italy)
d.	Removed Impurity:	O ₂ & H ₂ O
e.	Impurity Outlet Level:	O ₂ <0.1 ppm, H ₂ O <0.4
f.	Connection Type:	¼" DB
g.	Dimensions:	dia 42, length 530 mm
h.	Weight:	1.4 Kg
i.	Filtration:	20um
j.	Maximum Pressure:	50bar
k.	Brand:	Sertronic France/EU

3. **Standard Accessories.** All std accessories including Vaseline oil for Liquid discharge filter.

4. **Special Instructions**

- Firm's offer will be accompanied with the foreign manufacturer proforma invoice (in original).
- The firm will provide original OEM certificate (both hard & soft copies) for dealership authentication.
- Store will be brand new ex-factory and latest model of current year's production.
- Quotee firms will ensure provision of and detail list of accessories at the time of technical scrutiny.

- e. The quotee firms will provide comparative technical data with specifications & special instructions for evaluation / scrutiny of the offered equipment.
- f. All standard accessories should be clearly defined in quotation.
- g. A set of operating instructions, maintenance manual and repair manual will be supplied with the equipment free of cost.
- h. It should be certified the firm that the store does not contain ozone depleting substances (ODS).
- i. The supplier Firm will install the part free of cost.
- j. The equipment will be supplied with all accessories, fitted for immediate operation on receipt. All accessories required for testing should be included as standard accessories and not optional accessories.
- k. Incomplete offers will not be entertained.
- l. Supplier / Firm will be responsible for following:-
- (1) Complete installation of the offered eqpt at CID Kci.
 - (2) Comprehensive trg of the CID staff.
 - (3) Provision of necessary safety equipment.

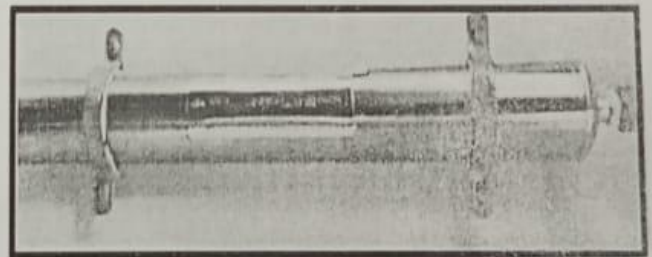
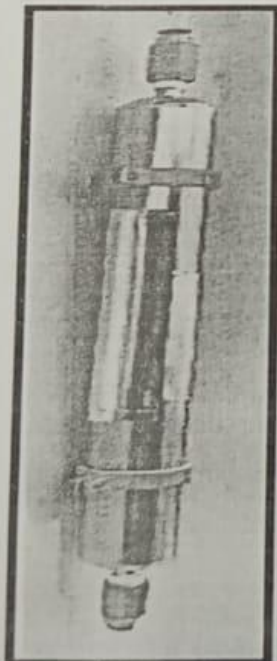

SPECS – WATER TLR

Ser	Description	Tlr Mtd
1.	Cap	1250G/1500G/1750G
2.	Sheet	3 mm
3.	Frame	8"x3" channel type, reinforced
4.	Filling Points	02 x filling points
5.	Tank Fixing on Frame	1250 Gallons; Two point padding 1500 Gallons; Two point padding 1750 Gallons; Two point padding
6.	Ladder	01 No (Two point padding)
7.	Road Sprinkler	1 No. at rear side
8.	Shape	Oval/ Semi-elliptical; ensuring low center gravity
9.	Tyres/ Rims	4 No. (9.00x20)
10.	Drain Value	02 No. (via pump & bottom tank)
11.	Filling Device	Water set (centrifugal Pump) 2" x 2.5" with ball valves 7 nec fitting with PTO Drive
12.	Del House	2"x100 ft, canvas
13.	Suction House	3' x 20 ft for suction from any external source like pound, reinforced PVC
14.	Inside Paint	Antirust
15.	Water Gun	Water gun for distant spray (70 ft) for washing trees etc
16.	Contact Details	Muhammad Farhan (Deputy Manager) Phone: +924237911021 Cell: +923124959949

GENERAL STAFF REQUIREMENT (GSR)

MICROSCOPE FOR MATERIAL IDENTIFICATION & FINESSE OF WOOL

1. **Introduction.** To identify quality of wool and for segregation of goose and duck feather a high power digital microscope is required. Microscope having magnifying power 1000x has capability to comply with such difficult tasks.

Purpose. Identification of fiber & quality of wool are important tests in Textile testing. Goose and duck cluster are used as insulation material in down jacket & trouser and sleeping bag HA. To perform such tasks a high power microscope is required in textile lab.

3. **Comply Test Std.** IDFB-Part-12, ASTM D 3992, ASTM D 2130, ISO 137

4. **Tech Specifications**

- a. Magnifying Power: 40 x - 1000 X (Binocular)
- b. Auto capturing auto images, dia, length and width
- c. Large LCD display for easy identification of fibers
- d. High power digital camera for accurate segregation/ identification of fibers
- e. Intensity adjustable illumination with LED light
- f. Software compatible with windows, Mac Os X
- g. Full solid metal frame
- h. Eqpt with self cal module
- i. Provide necessary std calibration scale.

5. **Accessories**

The firm will provide all required accessories including following

- a. UPS
- b. Voltage stabilizer
- c. PC Sys Core i5 with Large LCD
- d. Reference testing material with known readings

Country of origin. USA/UK/EU

7. **After Sale Service**

- a. 24 month warranty including free maintenance and changing of instrument components.
- b. Lifelong technical assistance and facility of after sale service engineers

INTRODUCING
THE OMAX HDLT CAMERA

High-Definition | Compact
Anti-Trip Video

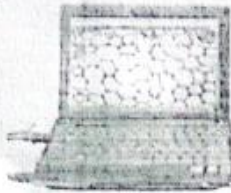

\$248.99

Recommended Accessories

Specifications:

- Model: XM82EC02
- Total magnification: 40X-100X-400X-1000X
- Eyepieces: widefield WF10X
- Objectives: achromatic DIN 4X, 10X, 40X(S), 100X(S, Oil)
- Viewing head: 45° inclined 360° swiveling binocular
- Interpupillary distance: sliding adjustable 2-3/16" - 2-15/16" (55-75mm)
- Diopter: adjustable on both ocular eyetubes
- Nosepiece: revolving quadruple
- Stage: double layer X-Y mechanical stage with scales, size: 4-1/2" x 4-15/16" (115mm x 125mm), translation range: 2-13/16" x 1-3/16" (70mm x 30mm)
- Stage upward moving lock protects objective and slides
- Condenser: NA1.25 Abbe condenser with iris diaphragm
- Illumination: transmitted (lower) LED light, intensity adjustable
- Focus: Coaxial coarse & fine knobs on both sides
- Full solid metal frame construction with stain resistant enamel finish
- Power supply: AC/DC adapter, 100V-240V (UL approved)
- Digital camera:
 - true color 640 x 480 pixels
 - 0.45X reduction lens to get larger field of view
 - Software compatible with Windows, Mac OS X (see below for version information)
 - Capturing microscope images, recording live video, measuring lengths, angles, areas, editing images
- Dimension: 5-7/16" x 7-1/8" x 13" (23cm x 18cm x 33cm)
- Package weight: 11 lb (5 kg)

GENERAL STAFF REQUIREMENT (GSR)**MELT FLOW INDEX TESTER**

1. **Introduction.** Use of polymer / Plastic is increasing day by day in production of different stores i.e. Bottle water Polythene, Can Plastic and other different packing material made of thermoplastic polymer. Melt Flow index provides a means of measuring flow of a melted material which can be used to differentiate grades, or determine the extent of degradation of the plastic as a result of molding. Testing of flow property gives an idea of purity of thermoplastic polymer.

2. **Purpose.** Melt Flow Index Tester is used to test the flow ability of thermoplastic polymer under high temperature, such as polyethylene, polypropylene, nylon and other plastic polymers. The automatic temperature control methods of the machine three kinds of blanking ways, manual, timing and automatic control according to operation method, which can realize melt-mass flow rate (MFR) and melt-volume flow rate (MVR) two test methods. This Eqpt is used to determine the flow values of Thermoplast Plastic. It determines the numerical expression of capability to flow.

3. **Test Standards**

- a. ISO 1133
- b. ASTM D-1238

4. **Tech Specifications**

a. Test Range	:	0.1 to 800 gm / 10min
b. Timing Accuracy	:	0.1 sec
c. Temperature Range	:	0°C to 400°
d. Controlling Accuracy	:	± 2°C
e. Displacement Accuracy	:	0.01 mm
f. Standard Load	:	960g, 1640g, 2500g, 5000g
g. Combination load	:	1200g, 2160g, 3800g, 5000g
h. Material cutting method	:	Manual, timing and automatic cutting
Barrel diameter	:	Φ2.095±0.005mm

5. **Accessories**

- a. Standard Calibration weights 10 g, 100 g, 500g, 4000g (or as specified in tech manual)
- b. OEM Calibration certification including relevant CRM's of Polyethylene, Propylene, Nylon and PVC of Known Melt Flow Index Value.

Saved by 6880

- c. UPS for power backup
- d. Voltage stabilizer
- e. Operational / repair manual to be provided.
6. **Country of origin.** USA/UK/EU
7. **Revision of Test Methods Literature.** Test methods, operational, maintenance and repair manuals, literature shall be provided by the firm.
8. **Training by supplier.** The firm will provide necessary / required operational training (min of 05 days) to the testing staff free of cost.
9. **After Sale Service**
 - a. 24 month warranty including free maintenance and changing of instrument components.
 - b. Lifelong technical assistance and facility of after sale service engineers
10. **Calibration Certificate.** Calibration Certificate of equipment shall be provided by the firm after installation.
11. **Safety and Reliability.** Power supply and all interconnect components in contact with AC line power should be CE and KUL certified